



FES Brands North America

Commercial Kitchen Supply

FES BRANDS



Who are we



At FES Brands North America, we focus on providing private label services to dealers in the food service and hospitality industry. Our deep product knowledge and strong ties with many original equipment manufacturers enable us to achieve the business goal that strike outstanding balance between quality and cost of products. We offer a wide variety of products that adhere to the food service industry standard. Our all-inclusive private label services include product sourcing, manufacturing, and logistics handling. In addition, we collaborate with partners to develop new products, and provide opportunity to strengthen their brand value and achieve outmost profit margins.

Copyright© 2024 FES Brands North America®

All rights reserved.

hello@fesbrands.us | [FESbrands.us](https://fesbrands.us) | 470-709-4628

Product images & specification subject to change without notice



FES BRANDS

MET Stainless Steel

Wall Mount Hand Sinks

Description

- 6" height backsplash with 2" return
- 304 S/S sink top and bowl
- Z-clip mounting bracket included
- 4" wall mounted faucet and 1-1/2" drainer included
- NSF listed

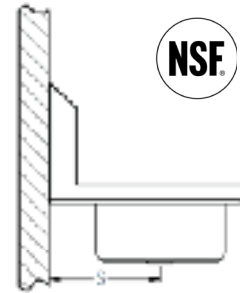
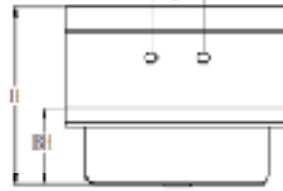
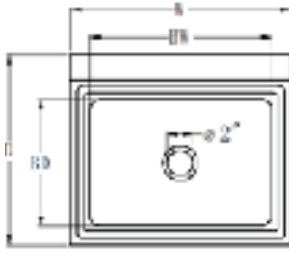

HS-1517S

Item #	D x W x H	BD x BW x BH	S	Weight
HS-1512S	15-3/4" x 12" x 14"	9" x 9" x 3-3/4"	8-1/2"	7 lbs
HS-1517S	15-3/4" x 17" x 14"	10" x 14" x 6"	8-1/2"	13 lbs

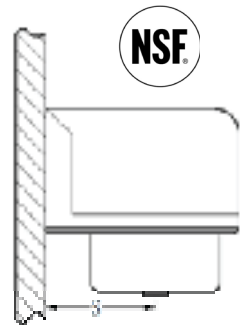
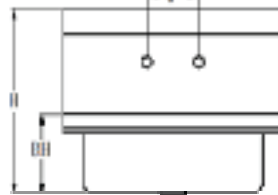
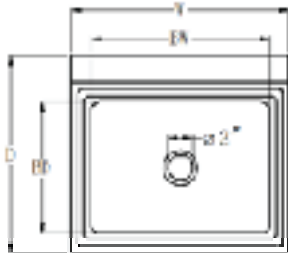

HS-1517BS

Item #	D x W x H	BD x BW x BH	S	Weight
HS-1512BS	15-3/4" x 12" x 14"	9" x 9" x 3-3/4"	8-1/2"	10 lbs
HS-1517BS	15" x 17" x 14"	10" x 14" x 6"	8-1/2"	16 lbs

Compartment Sinks

1-Compartment

Description

- 11-1/2" height backsplash
- 304 S/S 16Ga. or 18 Ga. sink top and bowl
- 8" O.C. splash mount faucet hole
- 3-1/2" strainer hole, drain basket included
- Stainless steel legs with side cross bracing
- NSF listed



N

No Drain Board

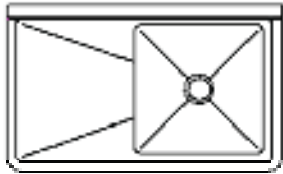

L

Left Drain Board

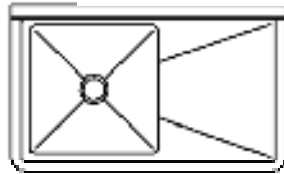

R

Right Drain Board

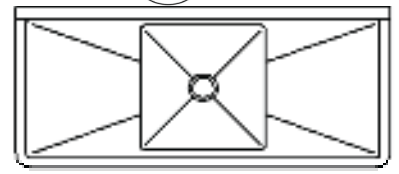

D

Left & Right Drain Board

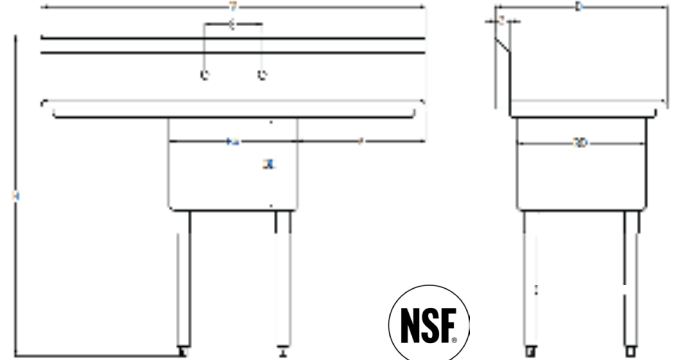

1-Compartment Sink without Drain Board

Item #	D x W x H	BD x BW x BH	Gauge	Weight
SE-15151N	18-5/8" x 18-1/4" x 43-7/8"	15" x 15" x 13"	18	27 lbs
SE-18181N	21-5/8" x 21-1/4" x 43-7/8"	18" x 18" x 13"	18	31 lbs
SEH-20201N	26" x 23-1/4" x 45"	20" x 20" x 14"	16	41 lbs
SEH-24241N	27-5/8" x 27-1/4" x 43-7/8"	24" x 24" x 13"	16	48 lbs

1-Compartment Sink with Left Drain Board

Item #	D x W x H	BD x BW x BH	A	Gauge	Weight
SE-15151L	21" x 33" x 45"	15" x 15" x 12"	15"	18	33 lbs
SE-18181L	24" x 39" x 45"	18" x 18" x 12"	18"	18	42 lbs
SEH-20201L	26" x 43" x 45"	20" x 20" x 14"	20"	16	56 lbs
SEH-24241L	30" x 51" x 45"	24" x 24" x 14"	24"	16	71 lbs

1-Compartment Sink with Right Drain Board

Item #	D x W x H	BD x BW x BH	A	Gauge	Weight
SE-15151R	21" x 33" x 45"	15" x 15" x 12"	15"	18	33 lbs
SE-18181R	24" x 39" x 45"	18" x 18" x 12"	18"	18	42 lbs
SEH-20201R	26" x 43" x 45"	20" x 20" x 14"	20"	16	56 lbs
SEH-24241R	30" x 51" x 45"	24" x 24" x 14"	24"	16	71 lbs

1-Compartment Sink with Left & Right Drain Board

Item #	D x W x H	BD x BW x BH	A	Gauge	Weight
SE-18181D	24" x 54" x 45"	18" x 18" x 12"	18"	18	52 lbs
SEH-24241D	30" x 72" x 45"	24" x 24" x 14"	24"	16	86 lbs

Compartment Sinks

2-Compartment

Description

- 11-1/2" height backsplash
- 304 S/S 16Ga. or 18 Ga. sink top and bowl
- 8" OC splash mount faucet hole
- 3-1/2" strainer hole, drain basket included
- Stainless steel legs with side cross bracing
- NSF listed

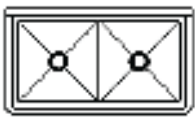
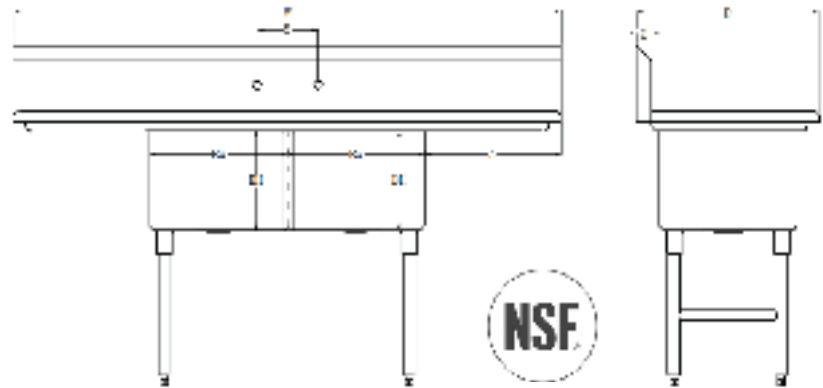

N
No Drain Board

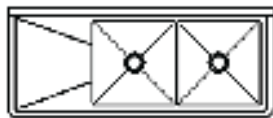

L
Left Drain Board



R
Right Drain Board

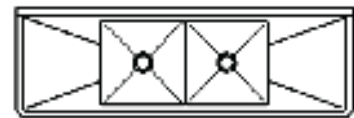

D
Left & Right Drain Board



2-Compartment Sink without Drain Board

Item #	D x W x H	BD x BW x BH	Gauge	Weight
SE-18182N	24" x 42" x 45"	18" x 18" x 12"	18	55 lbs
SEH-24242N	30" x 54" x 45"	24" x 24" x 12"	16	96 lbs



2-Compartment Sink with Left Drain Board

Item #	D x W x H	BD x BW x BH	A	Gauge	Weight
SE-18182L	24" x 57" x 45"	18" x 18" x 12"	18"	18	62 lbs
SEH-24242L	30" x 75" x 45"	24" x 24" x 14"	24"	16	110 lbs



2-Compartment Sink with Right Drain Board

Item #	D x W x H	BD x BW x BH	A	Gauge	Weight
SE-18182R	24" x 57" x 45"	18" x 18" x 12"	18"	18	62 lbs
SEH-24242R	30" x 75" x 45"	24" x 24" x 14"	24"	16	110 lbs



2-Compartment Sink with Left & Right Drain Board

Item #	D x W x H	BD x BW x BH	A	Gauge	Weight
SE-18182D	24" x 72" x 45"	18" x 18" x 12"	18"	18	69 lbs
SEH-24242D	30" x 96" x 45"	24" x 24" x 14"	24"	16	125 lbs

Compartment Sinks

3-Compartment

Description

- 11-1/2" height backsplash
- 304 S/S 16Ga. or 18 Ga. sink top and bowl
- 8" OC splash mount faucet hole
- 3-1/2" strainer hole, drain basket included
- Stainless steel legs with side cross bracing
- NSF listed

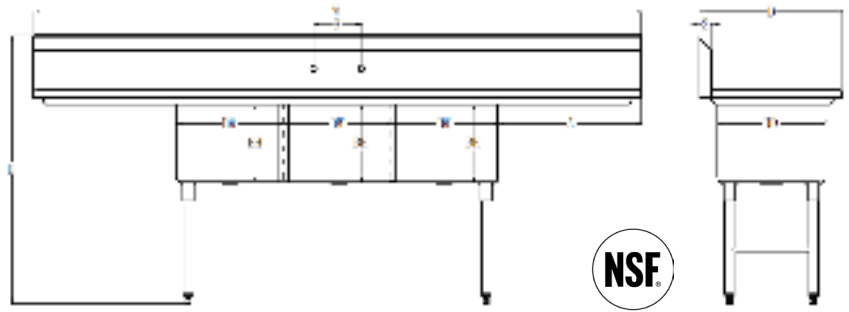

N
No Drain Board

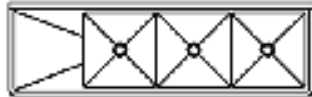

L
Left Drain Board



R
Right Drain Board



D
Left & Right Drain Board



3-Compartment Sink without Drain Board

Item #	D x W x H	BD x BW x BH	Gauge	Weight
SE-18183N	24" x 60" x 45"	18" x 18" x 12"	18	74 lbs
SEH-24243N	30" x 78" x 45"	24" x 24" x 12"	18	134 lbs



3-Compartment Sink with Left Drain Board

Item #	D x W x H	BD x BW x BH	A	Gauge	Weight
SE-15153L	21" x 36" x 45"	15" x 15" x 12"	15"	18	68 lbs
SE-18183L	24" x 75" x 45"	18" x 18" x 12"	18"	18	82 lbs
SEH-24243L	30" x 99" x 45"	24" x 24" x 14"	24"	16	149 lbs



3-Compartment Sink with Right Drain Board

Item #	D x W x H	BD x BW x BH	A	Gauge	Weight
SE-15153R	21" x 36" x 45"	15" x 15" x 12"	15"	18	68 lbs
SE-18183R	24" x 75" x 45"	18" x 18" x 12"	18"	18	82 lbs
SEH-24243R	30" x 99" x 45"	24" x 24" x 14"	24"	16	149 lbs



3-Compartment Sink with Left & Right Drain Board

Item #	D x W x H	BD x BW x BH	A	Gauge	Weight
SE-15153D	21" x 75" x 45"	15" x 15" x 12"	15"	18	74 lbs
SE-18183D	24" x 90" x 45"	18" x 18" x 12"	18"	18	90 lbs
SE-18183D24	24" x 102" x 45"	18" x 18" x 12"	24"	18	96 lbs
SE-16203D18	26" x 84" x 45"	20" x 16" x 12"	18"	18	90 lbs
SE-16203D24	26" x 96" x 45"	20" x 16" x 12"	24"	18	96 lbs
SEH-20203D	26" x 100" x 45"	20" x 20" x 14"	18"	16	132 lbs
SEH-24243D	30" x 120" x 45"	24" x 24" x 14"	24"	16	164 lbs

Compartment Sinks

4-Compartment Sink

Description

- 11-1/2" height backsplash
- 304 S/S 16Ga. or 18 Ga. sink top and bowl
- 8" OC splash mount faucet hole
- 3-1/2" strainer hole, drain basket included
- Stainless steel legs with side cross bracing
- NSF listed

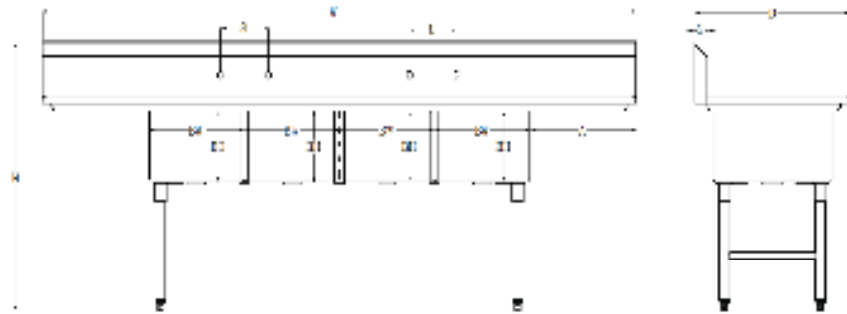

4-Compartment Sink with Left & Right Drain Board

Item #	D x W x H	BD x BW x BH	A	Gauge	Weight
SE-16204D18	26" x 100" x 45"	20" x 16" x 12"	18"	18	109 lbs

Prep Table with Sink



- 304 S/S 18 Ga. table top and sink bowl
- 6" backsplash
- 4" OC deck mount faucet hole
- 3-1/2" strainer hole, strainer included
- Stainless steel under shelf
- Adjustable S/S bullet feet
- NSF listed

Prep Table with Sink

Item #	D x W x H	Sink Bowl	Weight
WTPS-3048L	30" x 48" x 35"	Left	81 lbs
WTPS-3048R	30" x 48" x 35"	Right	81 lbs
WTPS-3060L	30" x 60" x 35"	Left	94 lbs
WTPS-3060R	30" x 60" x 35"	Right	94 lbs
WTPS-3072L	30" x 72" x 35"	Left	106 lbs
WTPS-3072R	30" x 72" x 35"	Right	106 lbs

Dish Tables

Clean Dish Tables

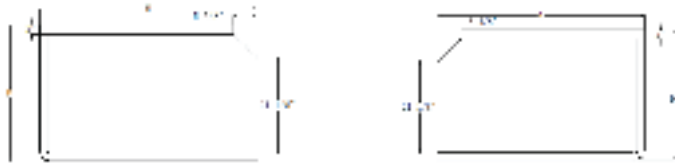
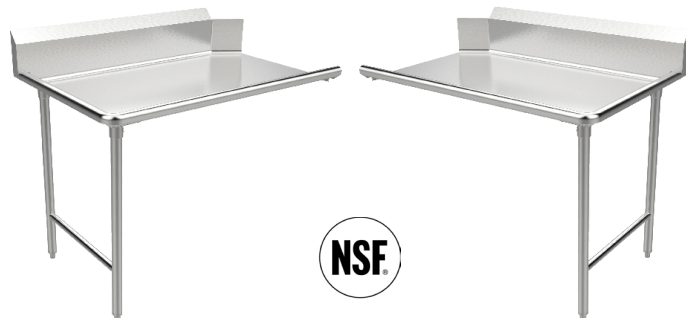

L
Left Side Model

R
Right Side Model

- 9" height backsplash
- 304 S/S 16 Ga. table top
- Stainless steel legs with side cross bracing
- NSF listed

Item #	D x W x H	Weight
CDT-24L	30" x 24" x 43"	30 lbs
CDT-24R	30" x 24" x 43"	30 lbs
CDT-30L	30" x 30" x 43"	34 lbs
CDT-30R	30" x 30" x 43"	34 lbs
CDT-36L	30" x 36" x 43"	38 lbs
CDT-36R	30" x 36" x 43"	38 lbs
CDT-48L	30" x 48" x 43"	50 lbs
CDT-48R	30" x 48" x 43"	50 lbs
CDT-60L	30" x 60" x 43"	60 lbs
CDT-60R	30" x 60" x 43"	60 lbs
CDT-72L	30" x 72" x 43"	68 lbs
CDT-72R	30" x 72" x 43"	68 lbs

Soiled Dish Tables

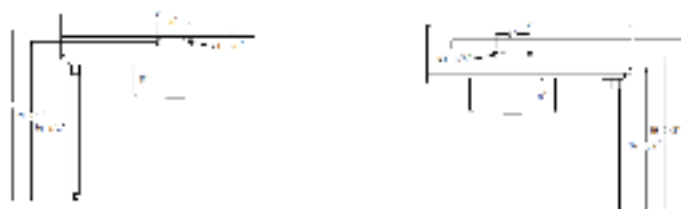
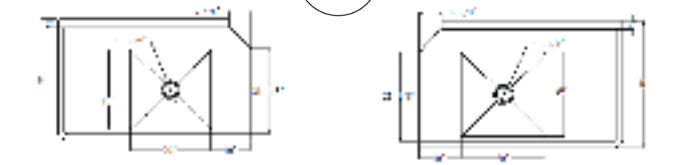

L
Left Side Model

R
Right Side Model

- 9" height backsplash
- 304 S/S 16 Ga. table top and sink bowl
- 20"L x 20"W x 8"H bowl size
- 8"OC splash mount faucet hole
- 3-1/2" strainer hole, strainer included
- Stainless steel legs with side cross bracing
- NSF listed

Item #	D x W x H	Weight
SDT-30L	30" x 30" x 43"	48 lbs
SDT-30R	30" x 30" x 43"	48 lbs
SDT-36L	30" x 36" x 43"	53 lbs
SDT-36R	30" x 36" x 43"	53 lbs
SDT-48L	30" x 48" x 43"	57 lbs
SDT-48R	30" x 48" x 43"	57 lbs
SDT-60L	30" x 60" x 43"	69 lbs
SDT-60R	30" x 60" x 43"	69 lbs
SDT-72L	30" x 72" x 43"	79 lbs
SDT-72R	30" x 72" x 43"	79 lbs

Work Tables

Economy Work Tables - 18 Ga.

- 430 S/S 18 Ga. table top
- 18 Ga. galvanized undershelf
- Table top reinforced with hat channel
- Galvanized legs with adjustable plastic bullet feet
- All work table uses 4 legs
- Shipped knocked-down in a box
- NSF listed

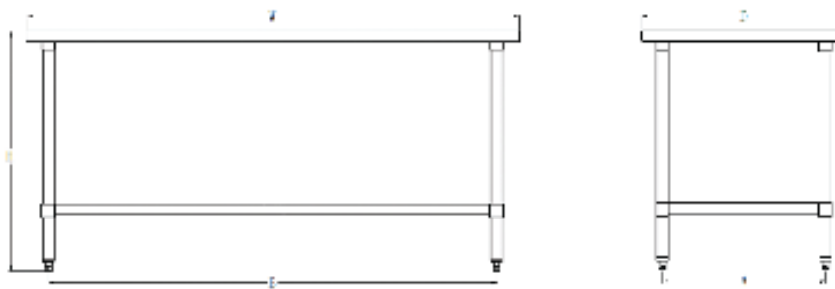

18 Ga. Economy Work Table 403 S/S top with Galvanized Undershelf

Item #	D x W x H	A	B	Weight
WTE-2424	24" x 24" x 35"	18"	17-1/8"	34 lbs
WTE-2430	24" x 30" x 35"	18"	23-3/8"	39 lbs
WTE-2436	24" x 36" x 35"	18"	29-3/8"	45 lbs
WTE-2448	24" x 48" x 35"	18"	41-3/8"	53 lbs
WTE-2460	24" x 60" x 35"	18"	53-3/8"	63 lbs
WTE-2472	24" x 72" x 35"	18"	65-3/8"	79 lbs
WTE-3012	30" x 12" x 35"	24"	7-1/8"	24 lbs
WTE-3015	30" x 15" x 35"	24"	10-1/8"	28 lbs
WTE-3018	30" x 18" x 35"	24"	13-1/8"	34 lbs
WTE-3030	30" x 30" x 35"	24"	23-3/8"	46 lbs
WTE-3036	30" x 36" x 35"	24"	29-3/8"	54 lbs
WTE-3048	30" x 48" x 35"	24"	41-3/8"	65 lbs
WTE-3060	30" x 60" x 35"	24"	53-3/8"	79 lbs
WTE-3072	30" x 72" x 35"	24"	65-3/8"	34 lbs

Work Tables - Heavy Duty

Item #	D x W x H	A	Weight
WTH-2430	24" x 30" x 35"	18"	42 lbs
WTH-2436	24" x 36" x 35"	18"	48 lbs
WTH-2448	24" x 48" x 35"	18"	58 lbs
WTH-2460	24" x 60" x 35"	18"	69 lbs
WTH-2472	24" x 72" x 35"	18"	86 lbs
WTH-2496	24" x 96" x 35"	18"	110 lbs
WTH-3024	30" x 24" x 35"	24"	42 lbs
WTH-3030	30" x 30" x 35"	24"	50 lbs
WTH-3036	30" x 36" x 35"	24"	57 lbs
WTH-3048	30" x 48" x 35"	24"	70 lbs
WTH-3060	30" x 60" x 35"	24"	83 lbs
WTH-3072	30" x 72" x 35"	24"	105 lbs
WTH-3096	30" x 96" x 35"	24"	141 lbs

- 304 S/S 16 Ga. table top
- 430 S/S 18 Ga. undershelf
- Table top reinforced with hat channel
- S/S legs with adjustable S/S bullet feet
- Work table 72" & over in length uses 6 legs
- Shipped knocked-down in a box
- NSF listed

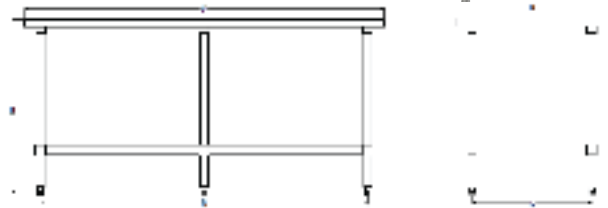

Work Tables - 18 Ga.

- 430 S/S 18 Ga. table top & undershelf
- Table top reinforced with hat channel
- S/S legs with adjustable S/S bullet feet
- Work table 72" & over in length uses 6 legs
- Shipped knocked-down in a box
- NSF listed

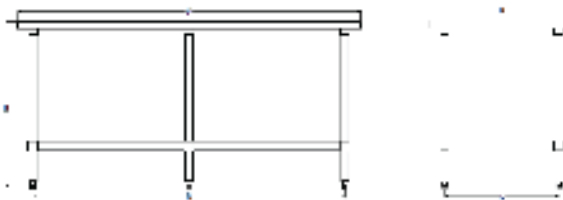

Item #	D x W x H	A	Weight
WT-2412	24" x 12" x 35"	18"	22 lbs
WT-2415	24" x 15" x 35"	18"	25 lbs
WT-2418	24" x 18" x 35"	18"	29 lbs
WT-2424	24" x 24" x 35"	18"	34 lbs
WT-2430	24" x 30" x 35"	18"	39 lbs
WT-2436	24" x 36" x 35"	18"	45 lbs
WT-2448	24" x 48" x 35"	18"	53 lbs
WT-2460	24" x 60" x 35"	18"	63 lbs
WT-2472	24" x 72" x 35"	18"	79 lbs
WT-2496	24" x 96" x 35"	18"	96 lbs
WT-3012	30" x 12" x 35"	24"	24 lbs
WT-3015	30" x 15" x 35"	24"	28 lbs
WT-3018	30" x 18" x 35"	24"	34 lbs
WT-3024	30" x 24" x 35"	24"	38 lbs
WT-3030	30" x 30" x 35"	24"	46 lbs
WT-3036	30" x 36" x 35"	24"	54 lbs
WT-3048	30" x 48" x 35"	24"	65 lbs
WT-3060	30" x 60" x 35"	24"	79 lbs
WT-3072	30" x 72" x 35"	24"	98 lbs
WT-3084	30" x 84" x 35"	24"	116 lbs
WT-3096	30" x 96" x 35"	24"	130 lbs

Work Tables with Backsplash

- 304 S/S 16 Ga. table top
- 430 S/S 18 Ga. undershelf
- 5" backspalsh
- Table top reinforced with hat channel
- S/S legs with adjustable S/S bullet feet
- Work table 72" & over in length uses 6 legs
- Shipped knocked-down in a box
- NSF listed

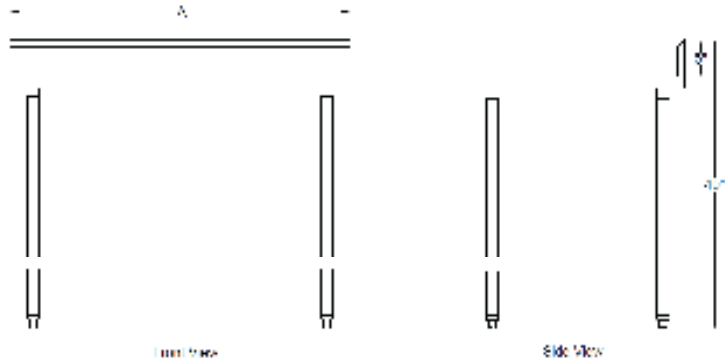

Work Table with 5" Backsplash

Item #	D x W x H	A	Weight
WTHB-3024	30" x 24" x 43"	24"	47 lbs
WTHB-3036	30" x 36" x 43"	36"	58 lbs
WTHB-3048	30" x 48" x 43"	48"	73 lbs
WTHB-3060	30" x 60" x 43"	60"	89 lbs
WTHB-3072	30" x 72" x 43"	72"	109 lbs
WTHB-3096	30" x 96" x 43"	96"	145 lbs

S/S Work Table Undershef

- 430 S/S 18 Ga. undershef
- Fits MET WTHB, WTH, WT series work table
- NSF listed

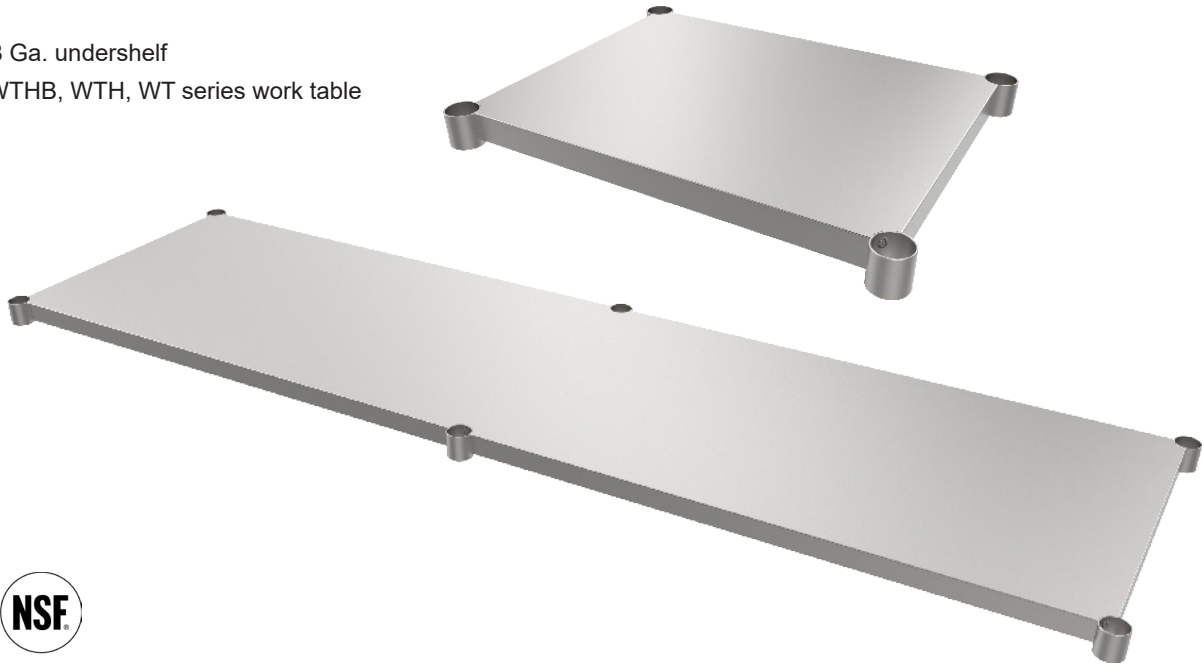

WT-US2472
WT-US3072
WT-US3096

Item #	D x W x H	Fit Table Size	Weight
WT-US2430	19-4/5" x 25-1/3" x 2"	24" x 30"	10 lbs
WT-US2436	19-4/5" x 31-1/3" x 2"	24" x 36"	12 lbs
WT-US2448	19-4/5" x 43-1/3" x 2"	24" x 48"	16 lbs
WT-US2460	19-4/5" x 55-1/3" x 2"	24" x 60"	20 lbs
WT-US2472	19-4/5" x 67-1/3" x 2"	24" x 72"	25 lbs
WT-US3030	25-4/5" x 25-1/3" x 2"	30" x 30"	13 lbs
WT-US3036	25-4/5" x 31-1/3" x 2"	30" x 36"	15 lbs
WT-US3048	25-4/5" x 43-1/3" x 2"	30" x 48"	20 lbs
WT-US3060	25-4/5" x 55-1/3" x 2"	30" x 60"	25 lbs
WT-US3072	25-4/5" x 67-1/3" x 2"	30" x 72"	30 lbs
WT-US3096	25-4/5" x 91-1/3" x 2"	30" x 96"	46 lbs

Equipment Stand

- 304 S/S 16 Ga. table top
- Table top is built 3-sided 1.5" turn up
- Table top is reinforced with hat channel
- S/S legs with adjustable S/S bullet feet
- Equipment stand with 60" & over in length uses 6 legs
- Shipped knocked-down in a box
- NSF listed

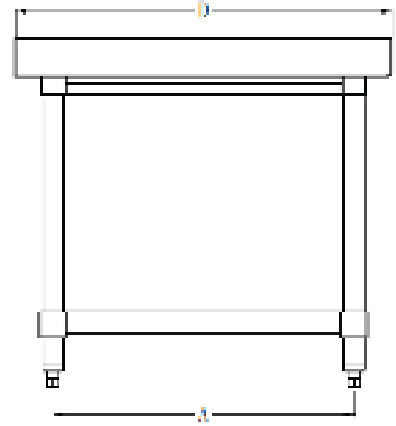
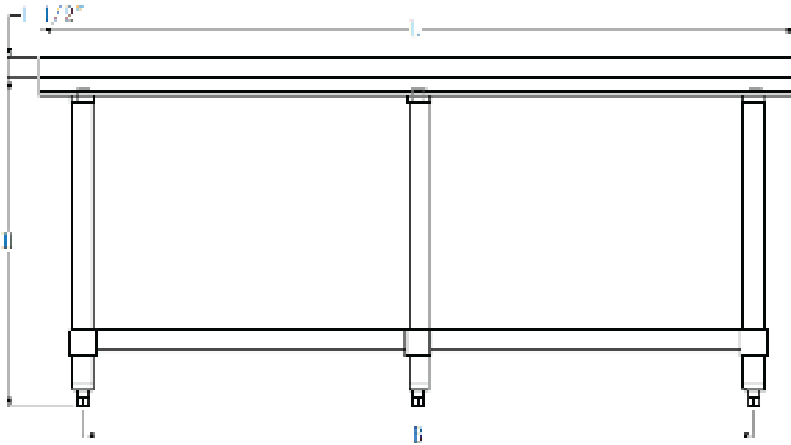

18 Ga. 430 S/S Equipment Stand				
Item #	D x W x H	A	B	Weight
ES-3012	30" x 12" x 26"	24"	7	27 lbs
ES-3018	30" x 18" x 26"	24"	13-1/3	35 lbs
ES-3024	30" x 24" x 26"	24"	17-1/2	40 lbs
ES-3036	30" x 36" x 26"	24"	29-1/2	52 lbs
ES-3048	30" x 48" x 26"	24"	41-1/2	68 lbs
ES-3060	30" x 60" x 26"	24"	53-1/2	88 lbs
ES-3072	30" x 72" x 26"	24"	65-1/2	101 lbs

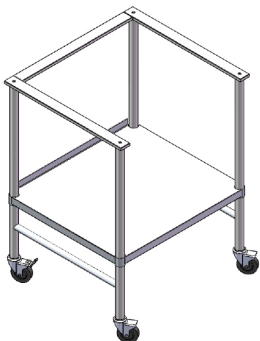

- For Vulcan Chip Warmer model VCW



Portable Chip Warmer Stand	
Item #	Weight
ES-27VCW	43 lbs

Rice Cooker Stand



- 430 S/S 18 Ga. table top & undershelf
- Table top reinforced with hat channel
- S/S leg with adjustable S/S bullet feet
- Shipped knocked-down in a box
- NSF listed

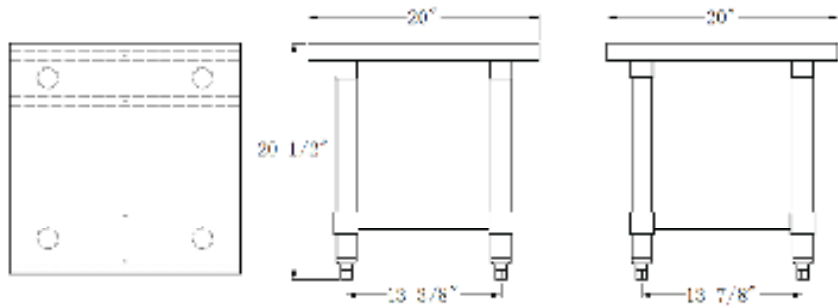

Rice Cooker Stand 18 Ga. 430 S/S		
Item #	D x W x H	Weight
ES-20	20" x 20" x 20-1/2"	24 lbs

Rice Warmer Cart



- 430 S/S 18 Ga. table top & undershelf
- S/S leg with 4" caster with break
- Shipped knocked-down in a box
- NSF listed

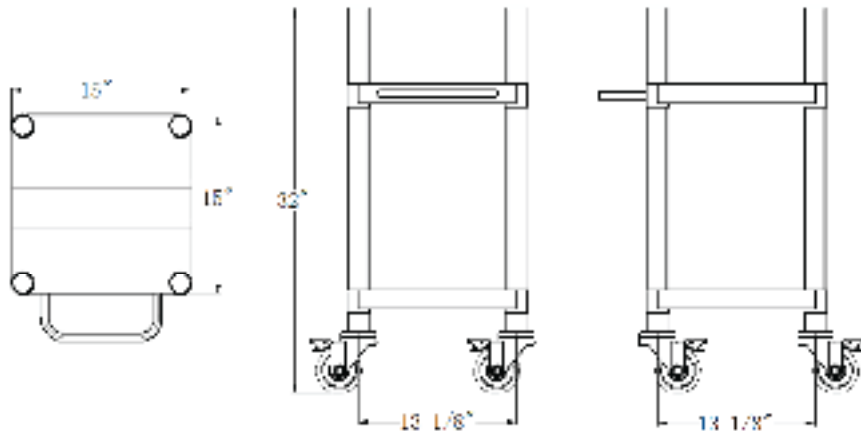

Rice Warmer Cart 18 Ga. 430 S/S		
Item #	D x W x H	Weight
ES-15	15" x 15" x 32"	29 lbs

S/S Wall Shelves

- 430 S/S 18 Ga.
- S/S mounting brackets included
- Shipped knocked-down in a box
- Units with pot rack comes with double pot hooks
- NSF listed

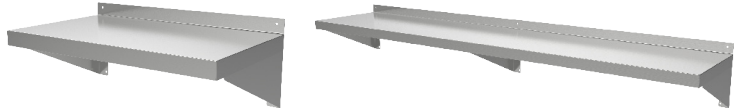

S/S Wall Shelves

Item #	D x W x H	Brackets	Weight
WS-1424	14" x 24" x 9-1/2"	2	9 lbs
WS-1430	14" x 30" x 9-1/2"	2	11 lbs
WS-1436	14" x 36" x 9-1/2"	2	12 lbs
WS-1448	14" x 48" x 9-1/2"	3	16 lbs
WS-1460	14" x 60" x 9-1/2"	3	20 lbs
WS-1472	14" x 72" x 9-1/2"	3	23 lbs
WS-1824	18" x 24" x 9-1/2"	2	12 lbs
WS-1830	18" x 30" x 9-1/2"	2	14 lbs
WS-1836	18" x 36" x 9-1/2"	2	16 lbs
WS-1848	18" x 48" x 9-1/2"	3	20 lbs
WS-1860	18" x 60" x 9-1/2"	3	24 lbs
WS-1872	18" x 72" x 9-1/2"	3	28 lbs

S/S Wall Shelves with Pot Rack

Item #	D x W	Brackets	Hooks
WSP-1524	15" x 24"	2	4
WSP-1530	15" x 30"	2	5
WSP-1536	15" x 36"	2	6
WSP-1548	15" x 48"	3	8
WSP-1560	15" x 60"	3	10
WSP-1572	15" x 72"	3	12
WSP-1584	15" x 84"	4	14
WSP-1596	15" x 96"	4	16

Microwave Oven Shelf

- 430 S/S 18 Ga. shelf
- S/S mounting brackets included
- Shipped knocked-down in a box
- NSF listed

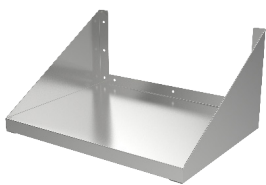

Item #	D x W x H	Brackets	Weight
MS-2418	18" x 24" x 14"	2	14 lbs

Slanted Wall Shelf

- 430 S/S 18 Ga. shelf
- S/S mounting brackets included
- Drain on the left
- Shipped knocked-down in a box
- NSF listed



Item #	D x W x H	# of Brackets	Weight
SW-2122	22" x 21" x 15-1/2"	2	15 lbs
SW-4222	22" x 42" x 15-1/2"	2	25 lbs
SW-6322	22" x 63" x 15-1/2"	2	35 lbs

S/S Double Overshelf

- 430 S/S 18 Ga. table top & undershelf
- S/S post, adjustable lower shelf
- L-shaped table mounting bracket
- Shipped knocked-down in a box
- NSF listed

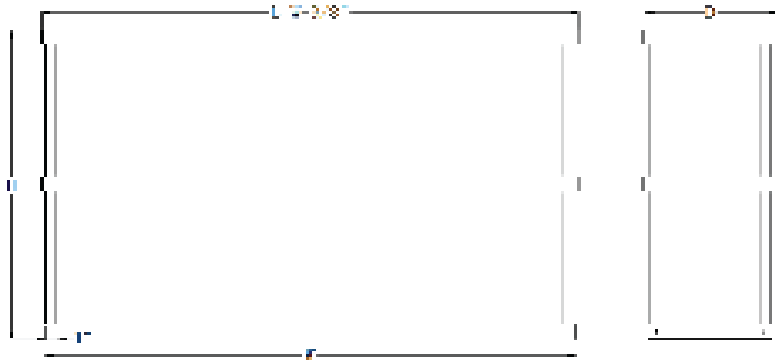

Item #	D x W x H	Weight
DOS-1436	14" x 36" x 32"	30 lbs
DOS-1448	14" x 48" x 32"	36 lbs
DOS-1460	14" x 60" x 32"	41 lbs
DOS-1472	14" x 72" x 32"	47 lbs
DOS-1836	18" x 36" x 32"	35 lbs
DOS-1848	18" x 48" x 32"	42 lbs
DOS-1860	18" x 60" x 32"	49 lbs
DOS-1872	18" x 72" x 32"	56 lbs

S/S Cabinet

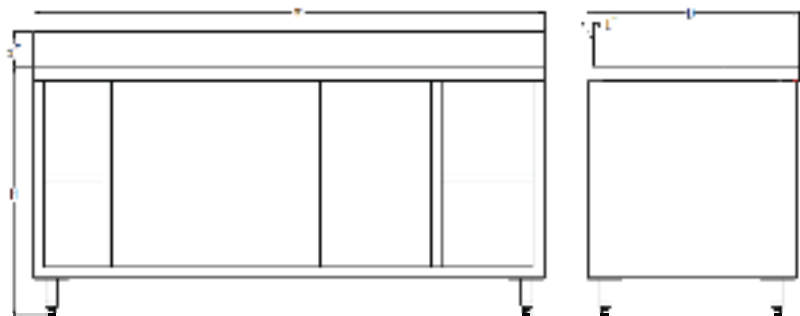
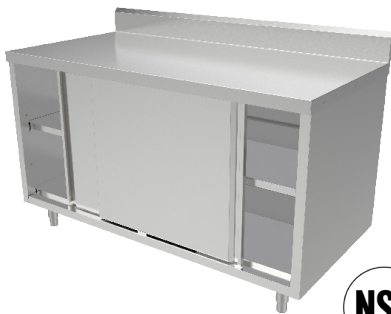

- 304 S/S 16 Ga. Top
- 430 S/S 18 Ga. body panels & shelf
- 5" backsplash
- Intermediate shelf & sliding doors
- Heavy duty adjustable S/S bullet feet
- Shipped knocked-down in a box
- NSF listed

Item #	D x W x H	Weight
CTD-3036	30" x 36" x 35"	165 lbs
CTD-3048	30" x 48" x 35"	204 lbs
CTD-3060	30" x 60" x 35"	241 lbs
CTD-3072	30" x 72" x 35"	279 lbs

S/S Dish Cabinet

- 430 S/S 18 Ga. top
- 430 S/S 22 Ga. body panels & shelf
- Intermediate shelf
- Heavy duty adjustable S/S bullet feet
- Shipped knocked-down in a box
- NSF listed

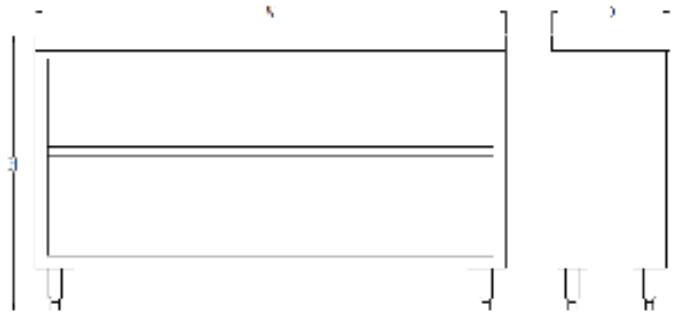

Item #	D x W x H	Weight
CDN-1536	15" x 36" x 35"	57 lbs
CDN-1548	15" x 48" x 35"	71 lbs
CDN-1560	15" x 60" x 35"	83 lbs
CDN-1572	15" x 72" x 35"	92 lbs

Tubular Dish Drainage Shelf



- Wall mount drainage shelf
- Stainless steel construction
- Mounting bolts included
- NSF listed

Item #	D x W	Weight	O.D. Tubing size
TDDS-2415	15" x 24"	12 lbs	1-5/8"
TDDS-3615	15" x 36"	16 lbs	
TDDS-4815	15" x 48"	22 lbs	
TDDS-6015	15" x 60"	30 lbs	
TDDS-7215	15" x 72"	40 lbs	

Beverage Table with Urn Troughs



- Built-in urn trough with drain
- 16 gauge stainless steel top
- 18 gauge stainless steel body
- 5" riser backsplash with standard electric outlet
- Stainless steel legs
- NSF listed

Item #	D x W	Weight	# of adjustable shelf
BEV-3036	30" x 36"	171 lbs	1
BEV-3048	30" x 48"	211 lbs	1
BEV-3060	30" x 60"	251 lbs	1
BEV-3072	30" x 72"	291 lbs	1

Pot Racks

Ceiling Mount Pot Racks

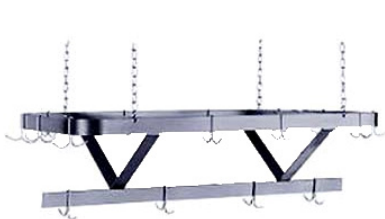

- Ceiling hung pot racks
- Triple bar design
- Stainless steel construction
- 24" plated hanging chains included
- NSF Listed

Item #	D x W	Hooks
PRC-36	22" x 36"	12
PRC-48	22" x 48"	14
PRC-60	22" x 60"	18
PRC-72	22" x 72"	22

Wall Mount Pot Racks

- Wall mount pot racks
- Double bar design
- Stainless steel construction
- NSF Listed



Item #	D x W	Hooks
PRW-36	12" x 36"	12
PRW-48	12" x 48"	14
PRW-60	12" x 60"	18
PRW-72	12" x 72"	22

Sinks

Dump Sink

- 304 S/S 20 Ga. sink top & bowl
- 430 S/S front & side panels
- 4" backsplash
- S/S legs with side cross bracing
- One compartment, no drain boards
- 4" wall mounted faucet & 1-1/2" drainer included
- NSF listed

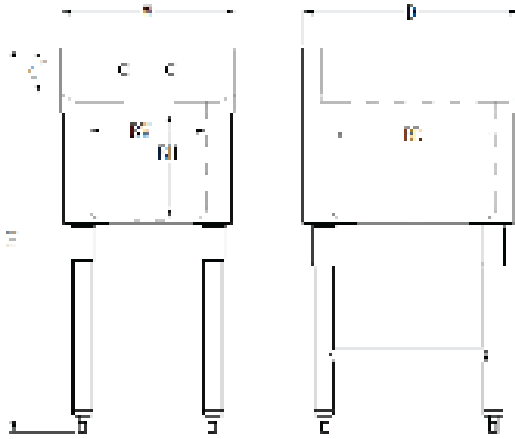

Item #	D x W x H	# of Sink Bowl	# of Drain Board	BD x BW x BH	Weight
UBS-118	18-1/2" x 15" x 33"	1	0	14" x 10" x 10"	39 lbs

Mop Sink

- 304 S/S 18 Ga. sink top & bowl
- 304 S/S 18 Ga. body panels
- NSF listed

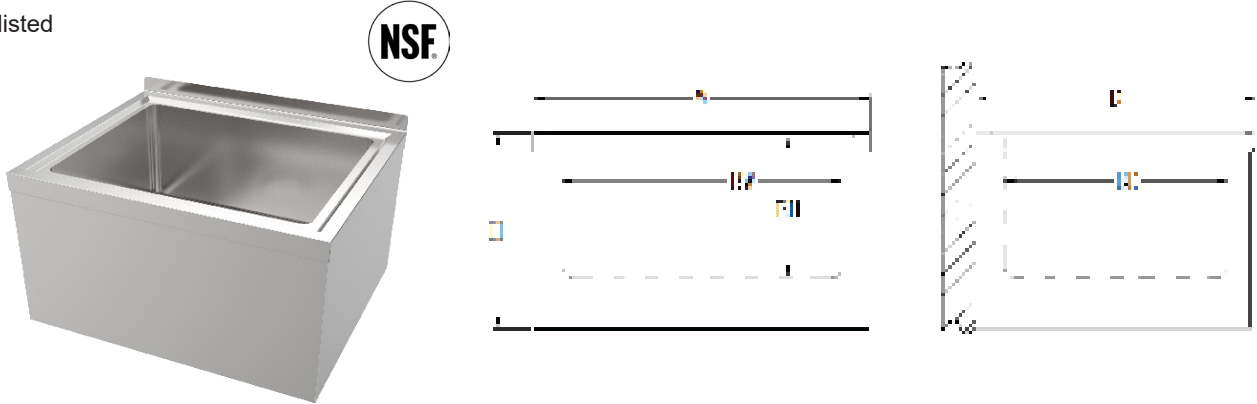

Item #	D x W x H	BD x BW x BH	Weight
SEM-201610	20" x 24" x 14"	16" x 20" x 10"	30 lbs
SEM-202010	24" x 24" x 14"	20" x 20" x 10"	35 lbs

Bar Sink

- 304 S/S 20 Ga. sink top & bowl
- 430 S/S front & side panels
- 4" backsplash
- 12" left & right drain boards (with drain board models)
- S/S legs with side cross bracing
- 4" wall mounted faucet & 1-1/2" drainer included
- NSF listed

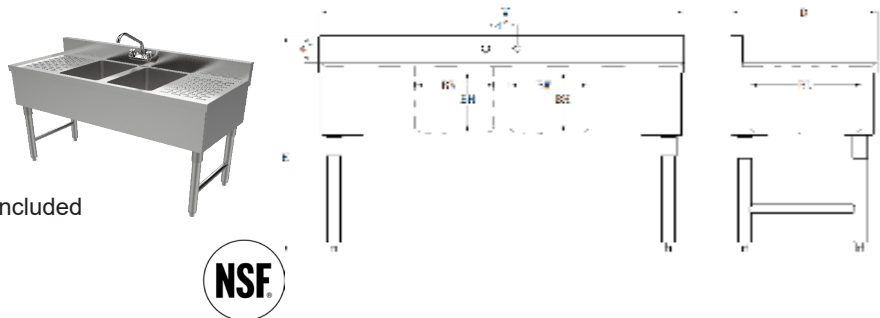

Item #	D x W x H	# of Sink Bowl	# of Drain Board	BD x BW x BH	Weight
UBS-227	18-1/2" x 24" x 33"	2	0	14" x 10" x 10"	43 lbs
UBS-246	18-1/2" x 46" x 33"	2	2	14" x 10" x 10"	51 lbs
UBS-358	18-1/2" x 58" x 33"	3	2	14" x 10" x 10"	62 lbs
UBS-470	18-1/2" x 70" x 33"	4	2	14" x 10" x 10"	78 lbs

Underbar

Ice Bin

- 304 S/S 18 Ga. sink top & bowl
- 430 S/S front & side panels
- 4" backsplash
- Poly foam insulation
- S/S legs with side cross bracing
- NSF listed

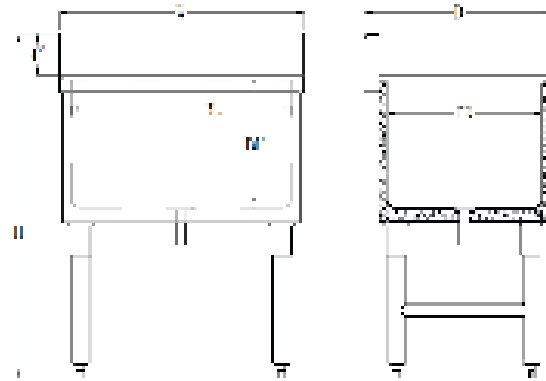

Item #	D x W x H	BD x BW x BH	Weight
UBIB-1824	18-1/2" x 24" x 33"	15" x 21" x 12"	48 lbs
UBIB-1830	18-1/2" x 30" x 33"	15" x 27" x 12"	55 lbs
UBIB-1836	18-1/2" x 36" x 33"	15" x 33" x 12"	65 lbs
UBIB-1848	18-1/2" x 48" x 33"	15" x 45" x 12"	79 lbs

Ice Bin with Cold Plate

- 304 S/S construction
- S/S legs and sockets
- H shape weld leg bracing
- Approximately 96-98 lbs ice capacity
- 3" height back splash
- NSF listed

Item #	D x W x H	Bowl Depth	Cold Plate
UBIB-247-CP	18-1/2" x 24" x 30"	12"	7-circuit cold plate
UBIB-307-CP	18-1/2" x 30" x 30"	12"	
UBIB-367-CP	18-1/2" x 36" x 30"	12"	
UBIB-2410-CP	18-1/2" x 24" x 30"	12"	10-circuit cold plate
UBIB-3010-CP	18-1/2" x 30" x 30"	12"	
UBIB-3610-CP	18-1/2" x 36" x 30"	12"	



Ice Bin Covers



- Ice bin sliding cover
- 18/304 stainless steel construction
- NSF listed

For Bins without Cold Plates			For Bins with Cold Plates		
Item #	Width	For Model	Item #	Width	For Model
IBSC-24	24"	UBIB-1824	IBSC-24-CP	24"	UBIB-247-CP UBIB-2410-CP
IBSC-30	30"	UBIB-1830	IBSC-30-CP	30"	UBIB-307-CP UBIB-3010-CP
IBSC-36	36"	UBIB-1836	IBSC-36-CP	36"	UBIB-367-CP UBIB-3610-CP
IBSC-48	48"	UBIB-1848			

Underbar Liquor Display

- 304 S/S 16 Ga. side panels
- 304 S/S 18 Ga. bottom & back panels
- 4" or 6" backsplash
- S/S legs with side cross bracing
- NSF listed



LQDR-1825
6" Backsplash



LQD-18

Item #	D x W x H	Weight
LQD-12	21-1/8" x 12" x 33"	30 lbs
LQD-18	21-1/8" x 18" x 33"	35 lbs
LQD-24	21-1/8" x 24" x 33"	41 lbs
LQD-30	21-1/8" x 30" x 33"	48 lbs
LQD-36	21-1/8" x 36" x 33"	52 lbs
LQDR-1825	25" x 18" x 30"	35.5 lbs
LQDR-3025	25" x 30" x 30"	47.1 lbs
LQDR-3625	25" x 36" x 30"	53.1 lbs

Glass Rack Station

- 304 S/S 20 Ga. sink top drain board
- 430 S/S body & side panels
- 4" backsplash
- Heavy duty adjustable S/S bullet feet
- NSF listed

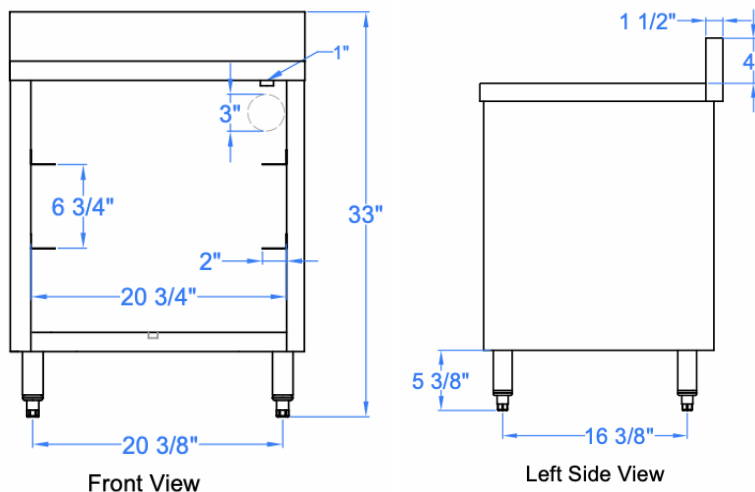

Item #	D x W x H	Weight
UBGR-242	21-1/8" x 12" x 33"	50.9 lbs
UBGR-243	21-1/8" x 18" x 33"	50.6 lbs

Blender Station

- 304 S/S 20 Ga. sink top drain board
- 304 S/S body & side panels
- 4" backsplash
- Heavy duty adjustable S/S bullet feet
- 4" wall mounted faucet & 1-1/2" drainer included
- NSF listed

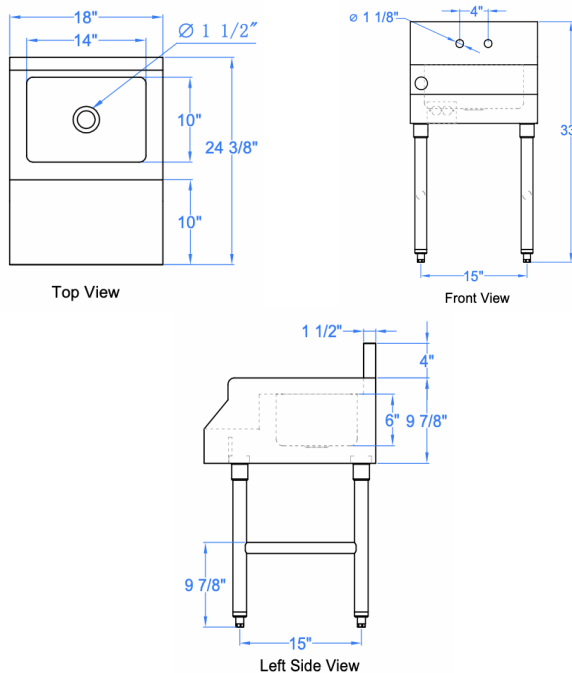

Item #	D x W x H	BD x BW x BH	Weight
UBBS-1824	24-3/8" x 18" x 33"	10" x 12" x 6"	28 lbs

Keg Racks



KRA-60

- 3 tier keg racks
- Rear straps can be purchased separately
- 1-5/16" dia. aluminum post

Item #	D x W x H	# of Kegs
KRA-42	20" x 42" x 76"	4
KRA-60	20" x 60" x 76"	6
KRA-72	20" x 72" x 76"	8

Aluminum Rear Straps for Keg Racks

Item #	Description
KRA-142	For 42" Keg Rack
KRA-160	For 60" Keg Rack
KRA-172	For 72" Keg Rack

Utility Carts



UBC-WS1836

- Wire utility cart
- 250 lbs capacity
- 3 shelves
- 4 swivel rubber casters with 2 brakes

Item #	D x W x H
UBC-WS1836	18" x 36" x 38"
UBC-WS2142	21" x 42" x 33"



UBC-1624SH

- 3 shelves utility cart
- 16 gauge angle legs
- 18 gauge 304 S/S construction
- All welded
- 350 lbs capacity

Item #	D x W x H
UBC-1624SH	15-1/2" x 27" x 33-1/2"
UBC-1827SH	18" x 27" x 34"
UBC-2135SH	21" x 35" x 34"

Green Shelf

- 850 lbs capacity for shelves shorter than 60"
- 600 lbs capacity for 60" & above shelves
- 74" height posts
- 2 shelves per box (minimum order per box)
- 4 posts per box (minimum order per box)

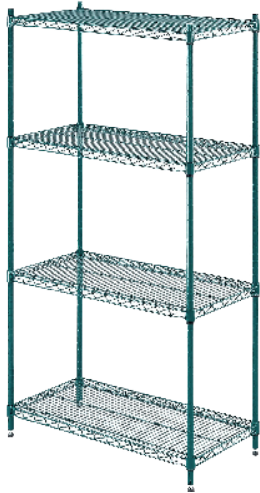

GS1436 & 4-tiers demo

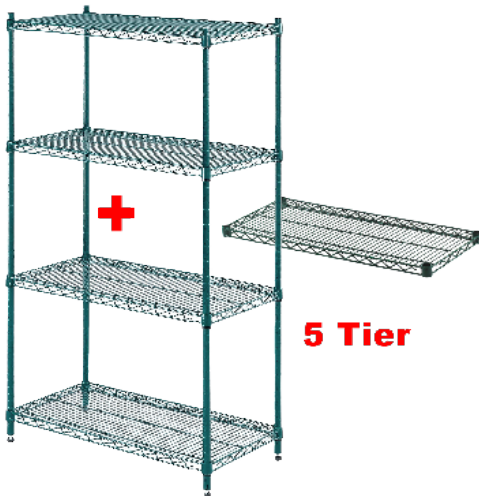

GS1436 & 5 tiers demo

Item #	D x W
GS1424	14" x 24"
GS1436	14" x 36"
GS1448	14" x 48"
GS1460	14" x 60"
GS1824	18" x 24"
GS1830	18" x 30"
GS1836	18" x 36"
GS1848	18" x 48"
GS1860	18" x 60"
GS1872	18" x 72"
GS2436	24" x 36"
GS2448	24" x 48"
GS2460	24" x 60"
GS2472	24" x 72"
GSC074	74" H shelving post

Bun Racks



BPR20



BPR-S20W (Stainless Steel, all welded)

- Open sides bun pan racks
- 3" spacing
- Welded angle slides
- 5" swivel casters
- Aluminum construction
- Ship knock-down
- NSF listed

Item #	H x W x D	Pan Capacity & Size
BPR10	38-1/2" x 20-3/8" x 26"	(10) 18" x 26"
BPR20	65-1/2" x 20-3/8" x 26"	(20) 18" x 26"
BPR-S20W	70-1/2" x 20-3/8" x 26"	(20) 18" x 26" (All welded)

Hood Filters



F1620



- Dimension are in nominal
- Dish washer safe
- Built-in handles
- Stainless steel
- 6 each per box (minimum order per box)
- Fully interchangeable with existing filters
- NSF & UL certified



F2020

Item #	H x W x D
F1216	12" x 16" x 2"
F1616	16" x 16" x 2"
F1620	16" x 20" x 2"
F1625	16" x 25" x 2"
F2016	20" x 16" x 2"
F2020	20" x 20" x 2"
F2025	20" x 25" x 2"



FT1721

(Fits all standard size exhaust hood filters)

Hood Filter Tank	
Item #	H x W x D
FT1721	34" x 17" x 21"

Accessories

Work Table Accessories

- Heavy duty drawer for work table
- Ball bearing slides
- 200 lbs load capacity
- Stainless steel construction
- NSF listed



Pre-Rinse Basket		
Item #	W x D	Capacity
DA-1818	18" x 18"	200 lbs

Fryer Accessories

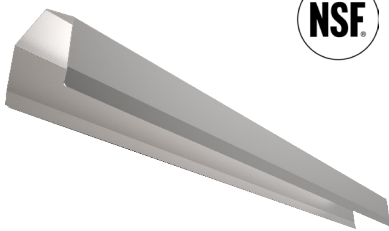

- 430 S/S 22 Ga.

Fryer Joiner Strip		
Item #	W x D x H	Weight
JSFF21	20-1/2" x 2" x 2"	1 lbs
JSFF23	22-1/2" x 2" x 2"	1 lbs
JSFF27	27" x 2" x 2"	1.2 lbs



Fryer Basket Hanger		
Item #	W x D x H	Fryer
BH50	15-1/3" x 4-1/2" x 2"	40-50 lbs
BH75	21" x 4-1/2" x 2"	75 lbs

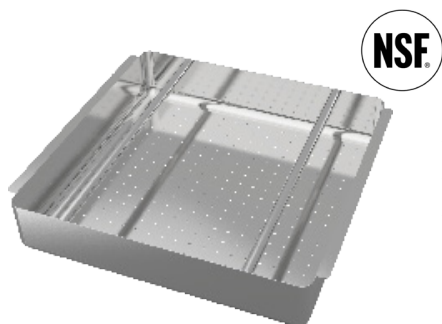

- 304 S/S 18 Ga.
- Perforated basket
- NSF listed

Pre-Rinse Basket		
Item #	For Sink Bowl Size	Weight
SDT-2020	20" x 20"	12 lbs

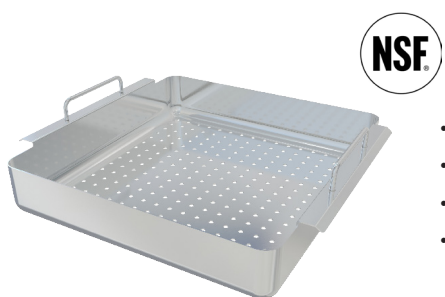

- 304 S/S 16 Ga.
- Perforated basket
- 3" deep basket
- NSF listed

Prep Sink Basket		
Item #	For Sink Bowl Size	Weight
PSB-1515	15" x 15"	7 lbs
PSB-1620	16" x 20"	9.5 lbs
PSB-1818	18" x 18"	9.5 lbs
PSB-2020	20" x 20"	11 lbs
PSB-2424	24" x 24"	15 lbs

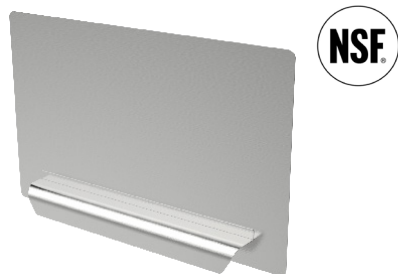

- 304 S/S 18 Ga.
- Welded bracket
- NSF listed

Sink Splash Guards		
Item #	For Sink Bowl Size	Weight
SSG15	15"	3 lbs
SSG18	18"	4 lbs
SSG20	20"	4 lbs
SSG24	24"	5 lbs



- 430 S/S 18 Ga.
- Welded bracket
- NSF listed

Fryer Splash Guard		
Item #	L x D	Weight
FSG2012	20" x 12"	4 lbs



FES BRANDS

We've specialized in fulfilling foodservice product requirements
for over 30 years



FES BRANDS

FES Brands North America

2024 Catalog

Address:
1750 Stone Ridge Dr. Suite B
Stone Mountain, GA 30083

FESbrands.us
Email: Sales@fesbrands.us
TEL: 470-709-4628