



FES Brands North America

Commercial Kitchen Supply

FES BRANDS



Who are we



At FES Brands North America, we focus on providing private label services to dealers in the food service and hospitality industry. Our deep product knowledge and strong ties with many original equipment manufacturers enable us to achieve the business goal that strike outstanding balance between quality and cost of products. We offer a wide variety of products that adhere to the food service industry standard. Our all-inclusive private label services include product sourcing, manufacturing, and logistics handling. In addition, we collaborate with partners to develop new products, and provide opportunity to strengthen their brand value and achieve outmost profit margins.

Copyright© 2024 FES Brands North America®

All rights reserved.

hello@fesbrands.us | [FESbrands.us](https://fesbrands.us) | 470-709-4628

Product images & specification subject to change without notice



FES Brands North America

Commercial Kitchen Supply

FES BRANDS



Who are we



At FES Brands North America, we focus on providing private label services to dealers in the food service and hospitality industry. Our deep product knowledge and strong ties with many original equipment manufacturers enable us to achieve the business goal that strike outstanding balance between quality and cost of products. We offer a wide variety of products that adhere to the food service industry standard. Our all-inclusive private label services include product sourcing, manufacturing, and logistics handling. In addition, we collaborate with partners to develop new products, and provide opportunity to strengthen their brand value and achieve outmost profit margins.

Copyright© 2024 FES Brands North America®

All rights reserved.

hello@fesbrands.us | [FESbrands.us](https://fesbrands.us) | 470-709-4628

Product images & specification subject to change without notice

Plain Back Upholstered Booths

Quickship



QAS-36 Deep Red



QAD-42 Black



QAD-36 Green



QAS-36 Grey



QAS-36 Brown

Plain Back Upholstered Booths Only

Model #	Type	Height	Weight (lb)
QAS-36	Single	36"	80
QAS-42		42"	85
QAD-36	Double	36"	115
QAD-42		42"	120

Available Vinyl Colors :

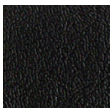

Black
Tsunami-ARM-126-M

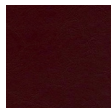

Deep Red
Sangria-ARM-120-M



Bright Red
Red-IND-053



Grey
Gunmetal-IND-8619



Green
Forest Green-IND-8571



Brown
Mocha-IND-8406



Yellow
Yellow-IND-050

Plain Back Upholstered Booths

Quickship Booths with Top and End Caps



QAS-36-TEC Gunmetal



QAS-42-TEC Mocha

Quick Ship Booth w/ Top Cap Only				
Model #	Cap Finish	Type	Height	lbs
QAS-36-TC	N	Single	36"	85
QAS-42-TC	DM		42"	90
QAD-36-TC	W	Double	36"	120
QAD-42-TC	BLK		42"	225
	C			

Quick Ship Booth w/ Two End Caps				
Model #	Cap Finish	Type	Height	lbs
QAS-36-EC	N	Single	36"	90
QAS-42-EC	DM		42"	95
QAD-36-EC	W	Double	36"	125
QAD-42-EC	BLK		42"	130
	C			





Quick Ship Booth w/ Top & Two End Caps				
Model #	Cap Finish	Type	Height	lbs
QAS-36-TEC	N	Single	36"	95
QAS-42-TEC	DM		42"	100
QAD-36-TEC	W	Double	36"	130
QAD-42-TEC	BLK		42"	135
	C			

**Please specify the cap finish color when ordering booth with caps: DM, N, W, BLK, C

Available Vinyl Colors :

						
Black Tsunami-ARM-126-M	Deep Red Sangria-ARM-120-M	Bright Red Red-IND-053	Grey Gunmetal-IND-8619	Green Forest Green-IND-8571	Brown Mocha-IND-8406	Yellow Yellow-IND-050

*Available Cap Colors:

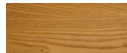
N - Natural 	DM - Dark Mahogany 	W - Walnut 	BLK - Black 	C - Cherry 
---	--	--	---	--

Plain Back Upholstered Booths

Three Button Back Upholstered Booths



QAS-36TB-3



QAS-42TB-3-TEC
*Featured with optional DM Top and End Cap

Quick Ship Three Button Back Upholstered Booth Only				
Model #	Cap Finish	Type	Height	lbs
QAS-36TB-3	N	Single	36"	80
QAS-42TB-3	DM		42"	85
QAD-36TB-3	W	Double	36"	115
QAD-42TB-3	BLK		42"	120
	C			

Quick Ship Three Button Back Upholstered Booth w/ Both Top and End Caps				
Model #	Cap Finish	Type	Height	lbs
QAS-36TB-3-TEC	N	Single	36"	95
QAS-42TB-3-TEC	DM		42"	100
QAD-36TB-3-TEC	W	Double	36"	130
QAD-42TB-3-TEC	BLK		42"	135
	C			

**Please specify the cap finish color when ordering booth with caps: DM, N, W, BLK, C

Available Vinyl Colors:



*Available Cap Colors:

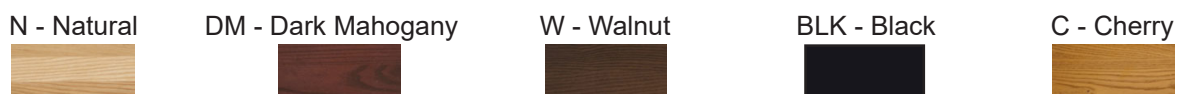

QUICKSHIP Wood Platform Booths

Wood Platform Booth Only

 AWS-48-DM	Frame Finish	Model #	Type	lbs	
	DM		AWS-48	Single	85
			AWS-60		98
			AWS-72		111
	W		AWD-48	Double	142
			AWD-60		163
			AWD-72		183

Wood Platform Booth w/ Seat Pad

 AWD-48WS-W	Frame Finish	Model #	Type	lbs	
	DM		AWS-48-WS	Single	102
			AWS-60-WS		117
			AWS-72-WS		132
	W		AWD-48-WS	Double	176
			AWD-60-WS		201
		AWD-72-WS	225		

Wood Platform Booth w/ Back Pad

 AWD-48WB-DM (Back with -COM Shown)	Frame Finish	Model #	Type	lbs	
	DM		AWS-48-WB	Single	94
			AWS-60-WB		109
			AWS-72-WB		125
	W		AWD-48-WB	Double	160
			AWD-60-WB		185
		AWD-72-WB	211		

Wood Platform Booth w/ Seat and Back Pads

 AWD-48WSB-W	Frame Finish	Model #	Type	lbs	
	DM		AWS-48-WSB	Single	111
			AWS-60-WSB		128
			AWS-72-WSB		146
	W		AWD-48-WSB	Double	194
			AWD-60-WSB		223
		AWD-72-WSB	253		

Finish Codes: **DM**-Dark Mahogany **W**-Walnut

Wood Platform Booth Vinyl Pad Options

Platform Booth Back Pad Options

Model # (Standard)	Description	lbs
BACK-PAD-AWSD-48	Back Pad for 48" Wood Platform Booth (EACH)	9
BACK-PAD-AWSD-60	Back Pad for 60" Wood Platform Booth (EACH)	11
BACK-PAD-AWSD-72	Back Pad for 72" Wood Platform Booth (EACH)	14

Platform Booth Seat Pad Options

Model # (Standard)	Description	lbs
SEAT-PAD-AWSD-48	Seat Pad for 48" Wood Platform Booth (EACH)	17
SEAT-PAD-AWSD-60	Seat Pad for 60" Wood Platform Booth (EACH)	19
SEAT-PAD-AWSD-72	Seat Pad for 72" Wood Platform Booth (EACH)	21

Metal Chairs

Quickship Chairs Seat Unattached

Ship in 5 Business Days

<div style="border: 1px solid red; padding: 2px; display: inline-block;"> 1 Year Frame Structural Warranty </div>		Frame Coat	HAHA	Model #	Vinyl Seat Colors	lbs
 77-YL-BLK  77-BS-YL-BLK	Black Powder Coat	32 18.5 17 17	77-YL	 -BLK  -RED  -BRED  -GRY  -GRN  -BRN  -YLW	19	
		42 30 17 17	77-BS-YL		23	
 77C-YL-BLK  77C-BS-YL-BLK	Clear Coat	32 18.5 17 17	77C-YL		19	
		42 30 17 17	77C-BS-YL		23	
 78-YL-BLK  78-BS-YL-BLK	Black Powder Coat	32 18.5 17 17	78-YL		19	
		42 30 17 17	78-BS-YL		23	
 85-YL-BLK  85-BS-YL-BLK	Black Powder Coat	34 18.5 17 17	85-YL		19	
		43 30 17 17	85-BS-YL		23	
 87-YL-BLK  87-BS-YL-BLK	Black Powder Coat	34 18.5 17 17	87-YL	19		
		42 30 17 17	87-BS-YL	23		

* All Quickship Metal Chairs come with standard vinyl seat unattached. 3/4" seat mounting screws included.

Swivel Barstools

Quickship

	Model # (Seat Attach)	W x D x H	lbs
	SR-2 (-UNA / -ATT)	Bottom Frame: 13" x 18" x 26" Seat: 14" R x 4" H	15
	SR-3 (-UNA / -ATT)	Bottom Frame: 13" x 18" x 26" Seat: 16" x 16" x 17"	22
	SR-8 (-UNA / -ATT)	Bottom Frame: 13" x 18" x 26" Seat: 14" R x 4.5" H	18
	SR-4J (-UNA / -ATT)	Bottom Frame: 17" x 23" x 26" Seat: 19" x 18" x 18"	32
	SR-5J (-UNA / -ATT)	Bottom Frame: 13" x 18" x 26" Seat: 19" x 18" x 17"	32

* -UNA are unattached seat & -ATT are attached seats

* ATS' Swivel Barstools with double ring bases are constructed of 1" chrome plated round steel tubing.

* Black Cross-over Bases are constructed of round tapered tubing with black enamel finish.

* All barstools use a flat swivel plate. Barstool bases are fully assembled

* CAL133 (California Tech Bulletin) upholstery. Not available on black vinyl seat

Build Your Own

QuickShip

Swivel Barstool Seats

		Model #	Descriptions	lbs
		SR-2B-S	4" H, 14" R Black Vinyl Seat	4
		SR-5B-J	17" H, 19" W, 18" D Black Vinyl Jumbo Seat	21
		SR-3B-S	Seat with Back Frame: 17" H, 16" W, 16" D Seat Radius ONLY: 14"R x 4.5"H	11
		SR-8-S	4.5" H, 15" R Black Vinyl Seat (GR 4)	7

Swivel Barstool Bases

		Model #	Descriptions	lbs
		SR-CF	2 Ring Chrome Frame	11
		SR-BF	Gloss Black Metal Frame w/ Chrome Ring	10

Swivel Plate

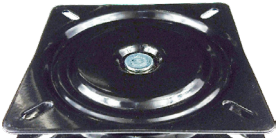
		Model #	Descriptions	lbs
	SR-3DEG	SR-3DEG	3 Degree Tilted Swivel Plate	3
	SR-FLAT	SR-FLAT	Level Swivel Plate	3

Outdoor Furniture

BLACK Powder Coat Finish

**1 Year
Limited Warranty**



Model#

Description

lbs



90B



90B-BS

34.0
17.5
16.0
16.5

90B

Black Powder Coated Metal Chair

13

43.5
27.5
16.5
16.0

90B-BS

Black Powder Coated Metal Barstool

18



91

33.0
17.5
16.5
17.5

91

Black Powder Coated Metal Chair

13



92



92-BS

32.0
18.0
16.5
17.0

92

Black Powder Coated Metal Chair

13

44.5
29.5
17.0
19.0

92-BS

Black Powder Coated Metal Barstool

17

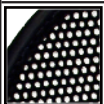

93

35.0
19.0
18.0
17.5

93

Black Powder Coated Metal Chair

13



94



94-BS

34.0
18.5
18.0
17.5

94

Black Powder Coated Metal Chair

12

46.0
30.0
18.0
17.5

94-BS

Black Powder Coated Metal Barstool

16

** Use outdoor chairs / barstools on flat floor surface only. Maximum weight capacity : 250 lbs

Outdoor Furniture

GREY Powder Coat Finish

**1 Year
Limited Warranty**



Model#

Description

lbs

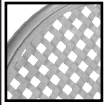

90G

34.0
17.5
16.0
16.5

90G

Grey Powder Coated
Metal Chair

13

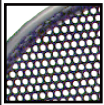

91G

33.0
17.5
16.5
17.5

91G

Grey Powder Coated
Metal Chair

13

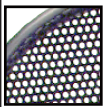

92G

32.0
18.0
16.5
17.0

92G

Grey Powder Coated
Metal Chair

13

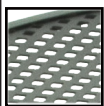

ALM30-GRY

30" round Open Mesh top
30" height outdoor table GREY
Finish

40

ALM3030-GRY

30" x 30" Square Open Mesh
top
30" height outdoor table GREY
Finish

42

ALM36-GRY

36" round Open Mesh top
30" height outdoor table GREY
Finish

50

ALM3636-GRY

36" x 36" Square Open Mesh
top 30" height outdoor table
GREY Finish

52

ALM3048-GRY

30" x 48" rectangle Open Mesh
top 30" height outdoor table
GREY Finish









44

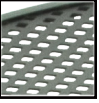

** ATS Outdoor Table Feature extra heavy-duty metal construction with a deep textured - Grey powder coat finish
** Use outdoor chairs / barstools on flat floor surface only. Maximum weight capacity : 250 lbs

Outdoor Furniture

BLACK Powder Coat Finish

	Model#	Description	lbs
 	AB30	30" round Fine Mesh top standard height outdoor table	29
	AB3030	30" x 30" square Fine Mesh top standard height outdoor table	33
	AB36	36" round Fine Mesh top standard height outdoor table	37
	AB3636	36" x 36" square Fine Mesh top standard height outdoor table	38
	AB3048	30" x 48" rectangular Fine Mesh top standard height outdoor table	44
	ABB30	30" round Fine Mesh top bar height outdoor table	36
 	ALM30	30" round Open Mesh top standard height outdoor table - BLACK Finish	40
	ALM3030	30" x 30" Square Open Mesh top standard height outdoor table - BLACK Finish	42
	ALM36	36" round Open Mesh top standard height outdoor table - BLACK Finish	50
	ALM3636	36" x 36" Square Open Mesh top standard height outdoor table - BLACK Finish	52
	ALM3048	30" x 48" rectangle Open Mesh top standard height outdoor table - BLACK Finish	44
 	OMT-30	30" round Wire Mesh top standard height outdoor table - BLACK Finish	40
	OMT-3030	30" x 30" Square Wire Mesh top standard height outdoor table - BLACK Finish	42
	OMT-36	36" round Wire Mesh top standard height outdoor table - BLACK Finish	50
	OMT-3636	36" x 36" square Wire Mesh top standard height outdoor table - BLACK Finish	52
	OMT-3048	30" x 48" rectangle Wire Mesh top standard height outdoor table - BLACK Finish	44
 	UMB-GRN	Green Umbrella for Outdoor Table With Umbrella Hole (Table Sold Separately) Dimension: 95" R x 102.5" H	69
	UMB-RED	Red Umbrella for Outdoor Table With Umbrella Hole (Table Sold Separately) Dimension: 95" R x 102.5" H	69
	UMB-BUR	Burgundy Umbrella for Outdoor Table With Umbrella Hole (Table Sold Separately) Dimension: 95" R x 102.5" H	69

** ATS Outdoor Table Feature extra heavy-duty metal construction with a deep textured - Black powder coat finish

** Standard height 30" & Bar height 42"

Aluminum Furniture

Quickship

**1 Year
Limited Warranty**

Model#

Description

lbs



AL30

27.5" Round Top
Standard Height Column

24

AL30H

27.5" Round Top
Bar Height Column

30



AL3030

27.5" x 27.5" Square Top
Standard Height Column

34



AL3048

27.5" x 45.5" Rectangular Top
Standard Height Column

40

* ATS Aluminum Furniture feature extra durable welded aluminum seating, and modern patterns.
* 1 Year limited warranty.

Isotop Outdoor/Indoor Table Tops

Quickship

Ship in 5 business days

**1 Year
Limited Warranty**



Aged Pine
(-201)



Compressed Grey
(-207)



Alcantara Black
(-202)



Grey Oak
(-212)



Indian Rose
(-213)



Pearl White
(-214)

Model #	Size	lbs
ATO2828 (-201, -202, -207, -212, -213, -214)	27.5" x 27.5"	19
ATO3048 (-201, -202, -207, -212, -213, -214)	31.5" x 47.2"	41
ATO3636 (-201, -202, -207, -212, -213, -214)	35.5" x 35.5"	32
ATO28 (-201, -202, -207, -212, -213, -214)	27.5"	17
ATO36 (-201, -202, -207, -212, -213, -214)	35.5"	25
ATO48 (-201, -202, -207, -212, -213, -214)	47.2"	45

** Thickness: 35mm (approximately 1.4") Indoor/Outdoor Tops - 1 Year limited warranty.

** 1/2" mounting screws included if order with ATS Table bases

** No screw included if order table tops only

Double Side 2" Laminated Panel Table Tops

Quickship

Ship in 5 business days

**1 Year
Limited Warranty**

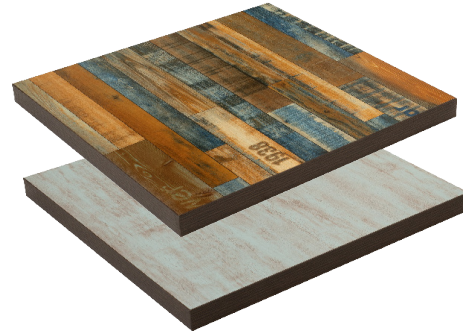

Model #	Size	lbs
ATP2430-BL/Y	24" x 30"	22
ATP3045-BL/Y	30" x 45"	38.5
ATP3048-BL/Y	30" x 48"	40
ATP3060-BL/Y	30" x 60"	52
ATP3072-BL/Y	30" x 72"	61.5
ATP3030-BL/Y	30" x 30"	27
ATP3636-BL/Y	36" x 36"	36
ATP30-BL/Y	30" R	23
ATP36-BL/Y	36" R	30

- ** Thickness: 2" composite vinyl drop edge indoor tops - 1 year limited warranty
- ** Double side laminated light blue wood grain / yangon color planks finish
- ** 3/4" mounting screws included if order with ATS Table bases
- ** No screw included if order table tops only

Reversible Table Tops

Quickship

Ship in 5 business days



B/DM - Black & Dark Mahogany

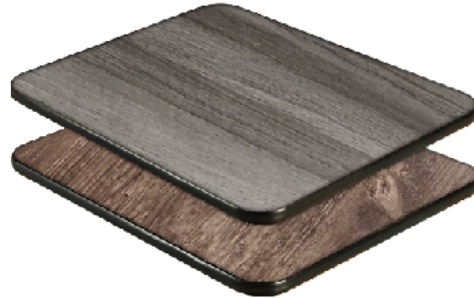

GY/BN - Grey & Brown

Size	Model #	lbs
24" X 30"	ADL2430 (-B/DM, -GY/BN)	19
30" X 30"	ADL3030 (-B/DM, -GY/BN)	23
30" X 45"	ADL3045 (-B/DM, -GY/BN)	34
30" X 48"	ADL3048 (-B/DM, -GY/BN)	37
30" X 60"	ADL3060 (-B/DM, -GY/BN)	47
30" X 66"	ADL3066 (-GY/BN)	56
30" X 72"	ADL3072 (-B/DM, -GY/BN)	57
36" X 36"	ADL3636 (-B/DM, -GY/BN)	34
24" R	ADL24 (-B/DM, -GY/BN)	12
30" R	ADL30 (-B/DM, -GY/BN)	19
36" R	ADL36 (-B/DM, -GY/BN)	27
42" R	ADL42 (-B/DM, -GY/BN)	37
48" R	ADL48 (-B/DM, -GY/BN)	48

** 1" thickness - melamine surface

** 3/4" mounting screws included if order with ATS Table bases

** No screw included if order table tops only

Self Edge Laminated Table Tops

Quickship

Ship in 5 business days



Size	Model #	lbs
24" X 30"	ATE2430-GY	24
30" X 30"	ATE3030-GY	29
30" X 45"	ATE3045-GY	46
30" X 48"	ATE3048-GY	50
30" X 60"	ATE3060-GY	55
30" X 66"	ATE3066-GY	62
30" X 72"	ATE3072-GY	65
36" X 36"	ATE3636-GY	45
24" R	ATE24-GY	22
30" R	ATE30-GY	26
36" R	ATE36-GY	37
42" R	ATE42-GY	49
48" R	ATE48-GY	60

** 2 inch thickness & laminate surface

** 3/4" mounting screws included if order with ATS Table bases

** No screw included if order table tops only

Resin Table Tops

Quickship

Ship in 5 business days



M - Mahogany



C/M - Cherry / Mahogany



VTW - Vintage Walnut



W - Walnut



Y/G - Yellow Green



WH - White Marble



PW - Pure White

Standard Corners are eased edges as shown. Customization are not available.

Size	Model#	lbs
24" x 30"	ATR2430 (-M, -C/M, -VTW, -W, -Y/G, -PW)	30
30" X 30"	ATR3030 (-M, -C/M, -VTW, -W, -Y/G, -WH, -PW)	37
30" X 45"	ATR3045 (-M, -C/M, -VTW -W, -Y/G, -WH, -PW)	53
30" X 48"	ATR3048 (-M, -C/M, -VTW, -W, -Y/G, -PW)	59
30" X 60"	ATR3060 (-M, -C/M, -VTW, -W, -Y/G, -WH, -PW)	74
30" X 66"	ATR3066 (-Y/G, -WH)	78
30" X 72"	ATR3072 (-M, -C/M, -VTW -W, -Y/G, -WH, -PW)	82
36" X 36"	ATR3636 (-M, -C/M, -VTW -W, -Y/G, -WH, -PW)	51
24" R	ATR24 (-M, -C/M, -VTW, -W, -Y/G, -PW)	17
30" R	ATR30 (-M, -C/M, -VTW, -W, -Y/G, -PW)	28
36" R	ATR36 (-M, -C/M, -VTW, -W, -Y/G, -PW)	33
48" R	ATR48 (-M, -C/M, -W)	76

** 2 inch thickness & resin Surface

** 3/4" mounting screws included if order with ATS Table bases

** No screw included if order table tops only



High Chairs / Hostess Stations / Trash Receptacles

High Chairs

	Frame Finish	Model #	lbs
 <p style="text-align: center;">N W DM</p>	-DM -N -W	HCW	14

Finish Codes: **DM**-Dark Mahogany **N**-Natural **W**-Walnut

Hostess Stations

	Model #	Type	lbs
 <p style="text-align: center;">WS1-BLK</p>	WS1-BLK	Melamine Waitress Station, Black	105
 <p style="text-align: center;">WS1-GRY</p>	WS1-GRY	Melamine Waitress Station, Grey	105

Trash Receptacles (with Liner)

	Model #	Type	lbs
 <p style="text-align: center;">TR1-BLK</p>	TR1-BLK	Melamine Trash Receptacle, Black	105
 <p style="text-align: center;">TR1-GRY</p>	TR1-GRY	Melamine Trash Receptacle, Grey	105
	TR-LINER	Trash Receptacle Liner	2

- ATS Trash Receptacles are built of a strong reinforced particle board core to withstand years of use. It includes a 32 gallon liner.
- TR1-BLK, Black Color w/ White "THANK YOU" Only, no custom color available. Built with Black Top Rails.
- TR1-GRY, Grey Color w/ Black "THANK YOU" Only, no custom color available.



FES BRANDS

Table Bases

3-PC Indoor & Outdoor Table Base Kits

Limited Life Time
Warranty
for All Table Bases



T0522
T0522-BAR



T2222, T2222-BAR
T2230, T2230-BAR
T3030, T3030-BAR
T3636, T3636-BAR



TR18, TR18-BAR
TR22, TR22-BAR
TR30, TR30-BAR



With Foot Ring

Model #	Description	lbs
3-PC Easy Assembly Indoor & Outdoor Table Base Kits		
T0522	5" x 22" with 3" Dia. Column	14
T2222	22" x 22" with 3" Dia. Column	14
T2230	22" x 30" with 3" Dia. Column	19
T3030	30" x 30" with 3" Dia. Column	19
T3636	36" x 36" with 4" Dia. Column	32
TR18	18" R with 3" Dia. Column	23
TR22	22" R with 4" Dia. Column	45
TR30	30" R with 4" Dia. Column	57
Bar Height 3-PC Easy Assembly Indoor & Outdoor Table Base Kits		
T0522-BAR	5" x 22" with 3" Bar Height Column	17
T2222-BAR	22" x 22" with 3" Bar Height Column	17
T2230-BAR	22" x 30" with 3" Bar Height Column	22
T3030-BAR	30" x 30" with 3" Bar Height Column	22
T3636-BAR	36" x 36" with 4" Bar Height Column	37
TR18-BAR	18" R. with 3" Bar Height Column	26
TR22-BAR	22" R. with 4" Bar Height Column	49
TR30-BAR	30" R. with 4" Bar Height Column	61
Add-on Accessory		
TF-3R	Indoor Table Base Foot Ring (3" Diameter)	7
TF-4R	Indoor Table Base Foot Ring (4" Diameter)	9

Recommended 3-PC Base Size By Table Top Size

Top Size	Recom. Base	Top Size	Recom. Base	Top Size	Recom. Base	Top Size	Recom. Base
24" Round	T2222 or TR18	30" Round	T2222 or TR22	36" Round	T3030 or TR22	42" Round	T3636 or TR30
24" x 24"		30" x 30"		36" x 36"		42" x 42"	
24" x 30"	T2230	30" x 42"	T2230 or TR22	36" x 48"	T0522 (2) or TR22	48" Round	
24" x 42"	T0522 (2) or T2230	30" x 45"					
24" x 48"		30" x 48"	T0522 (2) or T2230	30" x 60"	T2222 (2) or T2230 (2)		
24" x 60"	T0522 (2)			30" x 72"			

**Limited life time warranty for all table bases. Please contact us for more info

**Standard Base Height: 28 1/2", Bar Height: 40 1/4"

**See packing and handling fee page for pallet fee schedule info

2-PC Indoor & Outdoor Table Base Kits

Limited Life Time
Warranty
for All Table Bases



T0522M
T0522M-BAR



T2222M, T2222M-BAR
T2230M, T2230M-BAR
T3030M, T3030M-BAR
T3636M, T3636M-BAR



TR18M, TR18M-BAR
TR22M, TR22M-BAR
TR30M, TR30M-BAR



With Foot Ring

Model #	Description	lbs
2-PC Easy Assembly Indoor & Outdoor Table Base Kits		
T0522M	5" x 22" with 3" Dia. Column	14
T2222M	22" x 22" with 3" Dia. Column	14
T2230M	22" x 30" with 3" Dia. Column	19
T3030M	30" x 30" with 3" Dia. Column	19
T3636M	36" x 36" with 4" Dia. Column	32
TR18M	18" R with 3" Dia. Column	23
TR22M	22" R with 4" Dia. Column	45
TR30M	30" R with 4" Dia. Column	57
Bar Height 2-PC Easy Assembly Indoor & Outdoor Table Base Kits		
T0522M-BAR	5" x 22" with 3" Bar Height Column	17
T2222M-BAR	22" x 22" with 3" Bar Height Column	17
T2230M-BAR	22" x 30" with 3" Bar Height Column	22
T3030M-BAR	30" x 30" with 3" Bar Height Column	22
T3636M-BAR	36" x 36" with 4" Bar Height Column	37
TR18M-BAR	18" R. with 3" Bar Height Column	26
TR22M-BAR	22" R. with 4" Bar Height Column	49
TR30M-BAR	30" R. with 4" Bar Height Column	61
Add-on Accessory		
TF-3R	Indoor Table Base Foot Ring (3" Diameter)	7
TF-4R	Indoor Table Base Foot Ring (4" Diameter)	9

Recommended 2-PC Base Size By Table Top Size

Top Size	Recom. Base	Top Size	Recom. Base	Top Size	Recom. Base	Top Size	Recom. Base
24" Round	T2222M or TR18M	30" Round	T2222M or TR22M	36" Round	T3030M or TR22M	42" Round	T3636M or TR30M
24" x 24"		30" x 30"		36" x 36"		42" x 42"	
24" x 30"	T2230M	30" x 42"	T2230M or TR22M	36" x 48"	T0522M (2) or TR22M	48" Round	
24" x 42"	T0522M (2) or T2230M	30" x 45"					
24" x 48"		T0522M (2) or T2230M	30" x 48"	T0522M (2) or T2230M	30" x 60"	T2222M (2) or T2230M (2)	
24" x 60"	30" x 72"						

**Limited life time warranty for all table bases. Please contact us for more info

**Standard Base Height: 28 1/2", Bar Height: 40 1/4"

Table Base Parts

2-PC / 3-PC Table Base Parts

**Limited Life Time
Warranty
for All Table Bases**

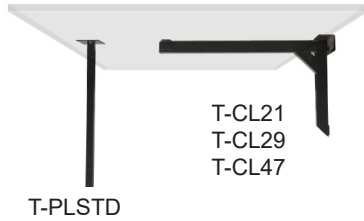

TC2503M
TC2504M
TC3703M-BAR
TC3704M-BAR



TC2503
TC2504
TC3703-BAR
TC3704-BAR



T0522-BB



T1315



T2222-BB, T2230-BB
T3030-BB, T3636-BB



TR18-BP, TR22-BP
TR30-BP, TR34-BP

Base & Column Prices		
Model #	Use Dia Size	lbs
Bottom Base Only for 2-PC / 3-PC Table Bases Kit		
T0522-BB	3" Diameter	6
T2222-BB	3" Diameter	9
T2230-BB	3" Diameter	11
T3030-BB	3" Diameter	12
T3636-BB	4" Diameter	15
TR18-BP	3" Diameter	16
TR22-BP	4" Diameter	28
TR30-BP	4" Diameter	44
2-PC Columns (Welded Spider Column, Bolt Set)		
TC2503M	3" Diameter	7
TC2504M	4" Diameter	10
TC3703M-BAR	3" Diameter	9
TC3704M-BAR	4" Diameter	14
3-PC Table Base Columns (Column, Bolt Set)		
TC2503	3" Diameter	5
TC2504	4" Diameter	8
TC3703-BAR	3" Diameter	7
TC3704-BAR	4" Diameter	12
Spider for 3-PC Table Base		
TC1315	3" & 4" Diameter	2.8

Case Pricing		
Model #	Qty/Case	lbs
Bottom Base Only for 2-PC / 3-PC Table Bases		
T0522-BB-CASE	10	63
T2222-BB-CASE	5	47
T2230-BB-CASE	5	57
T3030-BB-CASE	5	62
T3636-BB-CASE	2	77
TR18-BP-CASE	5	83
TR22-BP-CASE	2	58
2-PC Columns (Welded Spider Column, Bolt Set)		
TC2503M-CASE	8	59
TC2504M-CASE	6	63
TC3703M-BAR-CASE	8	75
TC3704M-BAR-CASE	6	87
3-PC Table Base Columns (Column, Bolt Set)		
TC2503-CASE	10	53
TC2504-CASE	8	67
TC3703-BAR-CASE	10	73
TC3704-BAR-CASE	4	50
Spider for 3-PC Table Base		
T1315-CASE	10	30



Table Levelers

Model #	lbs
GLIDE-AUTO (Hydraulic)	0.5
GLIDE-TBB (Adjustable)	0.02

Cantilever Table Bases

Model #	lbs
T-CL21	10
T-CL29	11
T-CL47	13
T-PLSTD	5



FES BRANDS

Miscellaneous

Hardware & Parts

Model #	Type	lbs
GLIDE-AUTO	Glide, hydraulic, self adjusting, for table base (price per pack of 4)	1.00
GLIDE-BTH	Glide, for booths and Trash Receptacle (price per each) (please specify model)	0.02
GLIDE-CBS-M	Glide, for metal chairs - SQUARE (price per each) (please specify model)	0.02
GLIDE-CBS-MO	Glide, for metal chairs - OVAL (price per each) (please specify model)	0.02
GLIDE-CBS-MR	Glide, for metal chairs - RECTANGULAR (price per each) (please specify model)	0.02
GLIDE-CBS-W	Glide, for wood chairs (price per pack of 4) (please specify model)	0.02
GLIDE-LGS	Metal Chair Leg Sleeve (price per each) (please specify model)	0.05
GLIDE-TBB	Glide, adjustable, for table base (price per each)	0.02
GLIDE-SRCF	Glide, for SR-CF	0.02
GLIDE-SRBF	Glide, for SR-BF	0.02
BRACKET-U-BLK	Bracket - Sydney U Black	0.02
BRACKET-U-BRE	Bracket - Sydney U Bronze	0.02
BRACKET-U-ZINC	Bracket - Sydney U Zinc	0.02
BRACKET-V-ZINC	Bracket - Sydney V Zinc (L)	0.02
FP-BRA	Brass Foot Plate	0.11
FP-CHM	Chrome Foot Plate	0.11
HDWE-MC	Hardware Pack, for metal chair	0.40
HDWE-WC	Hardware Pack, for wood chair	0.43
SCREW-B 3/4	Screw, for ATE / ATP table tops (box of 50)	0.30
SCREW-Z 1/2	Screw, 10 x 1/2 seat, zinc (box of 50)	0.30
SCREW-Z 3/4	Screw, 10 x 3/4 seat, zinc (box of 50)	0.30
TR-DR-TOP	Trash Receptacle Top Door	10
TR-DR-BTM	Trash Receptacle Bottom Door	10
TR-DR-LATCH	Trash Receptacle Door Latch	0.20
TR-HINGE	Trash Receptacle Hinge	0.06
TR-RAIL	Trash Receptacle Rail Set	1.00
TR-LINER	Trash Receptacle Rigid Liner, 32 gallon capacity, plastic	9.00
Model #	Swivels	
SR-FLAT	Barstool flat swivel plate	3.00
SR-3DEG	Barstool Beveled 3' degree swivel plate	3.00

Furniture Components

Model #	Upholstery Description	lbs
CAPE-UPH-AD	Replacement Upholstered End Cap, for double booths	2.00
CAPE-UPH-AS	Replacement Upholstered End Cap, for single booths	1.00
CAPT-UPH-ASD	Replacement Upholstered Top Cap (price per linear foot)	1.50
SEAT-PAD-ASD-46	Replacement Booth Seat Only , 46" long, for standard	23.00
SEAT-PAD-ASD	Replacement Booth Seat Only , Custom Length, Price Per FT	N/A
SEAT-CVR-ASD-46	Replacement Booth Seat Cover Only , 46" long	2.00
SEAT-CVR-ASD	Replacement Booth Seat Cover Only , Custom Length, Price Per FT	N/A
SEAT-PAD-ACRN	Replacement Corner Booth Seat Only , Custom Length, Price Per FT	N/A
SEAT-CVR-ACRN	Replacement Corner Booth Seat Cover Only , Custom Length, Price Per FT	N/A
5000	Replacement Upholstered Seat, for metal chair, Custom (Add -GR4 , -GR5, -GR6 for respective vinyl grade model)	4.50
5000-BLK	Replacement Black Vinyl Seat for metal chair	4.50
5000-RD	Replacement Red Vinyl Seat for metal chair	4.50
VINYL-FABRIC	Vinyl/Fabric Only (fabric yard)	2.00
VINYL-KICK	Black Vinyl- Kickplate, (price per lineal foot)	2.00
Model #	Wood Cap Description	lbs
CAPE-WD-AD	Replacement Wood End Cap, double vinyl booth	3.00
CAPE-WD-AS	Replacement Wood End Cap, single vinyl booth	2.00
CAPT-WD-ASD	Replacement Wood Top Cap (price per linear foot)	2.00
Model #	Wood Components for Metal Chairs & Barstools	lbs
77A-BACK	Replacement Veneer Back for 77A	2.00
77B-BACK	Replacement Veneer Back for 77B	2.00
77E-BACK	Replacement Veneer Back for 77E	2.00
6000	Replacement Veneer Seat for 77 Series	3.50
7000	Replacemt Solid Wood Seat for 77 Series	5.00
Model #	Wood Components for Wood Chairs & Barstools	lbs
SEAT-WC-VN	Replacement Veneer Seat for wood chair/barstool	3.50
SEAT-WC-WD	Replacemt Solid Wood seat for wood chair/barstool	5.00
Model #	Vinyl Description	lbs
T-MOLD-BULL	Vinyl - Bullnose T-Mold (specify color)	0.50
T-MOLD	Vinyl - T-mold (specify color)	0.20

Booths

Space Planning - Dimensions

ATS Single Upholstered Booth Upholstery Dimensions

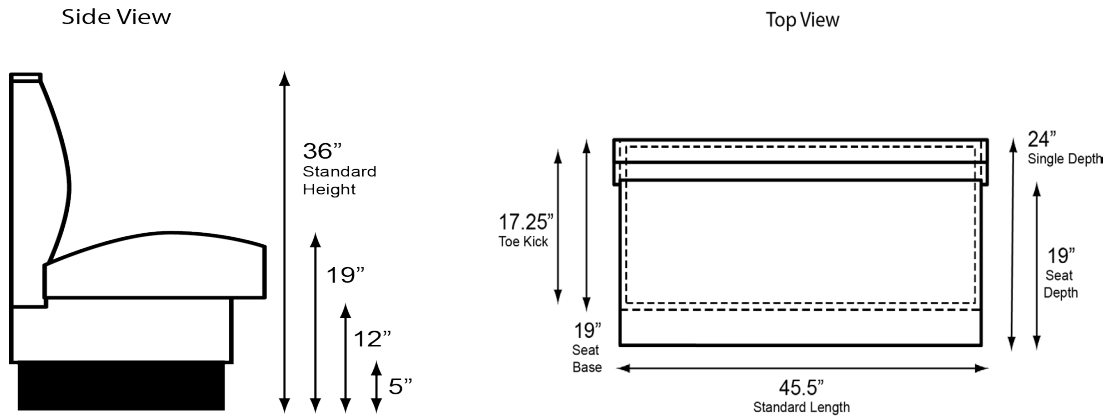

ATS Double Upholstered Booth Upholstery Dimensions

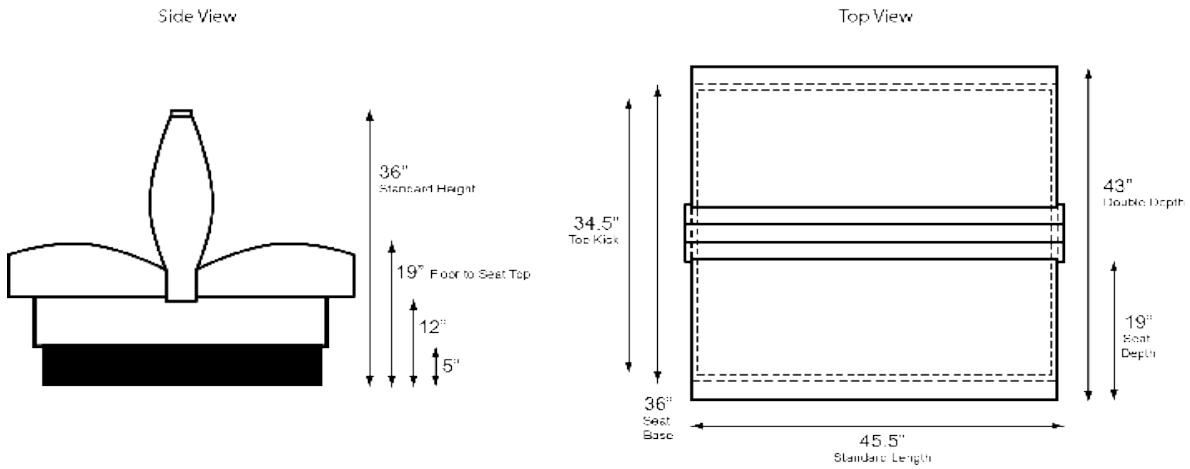

ATS Single Wood Booth Dimensions

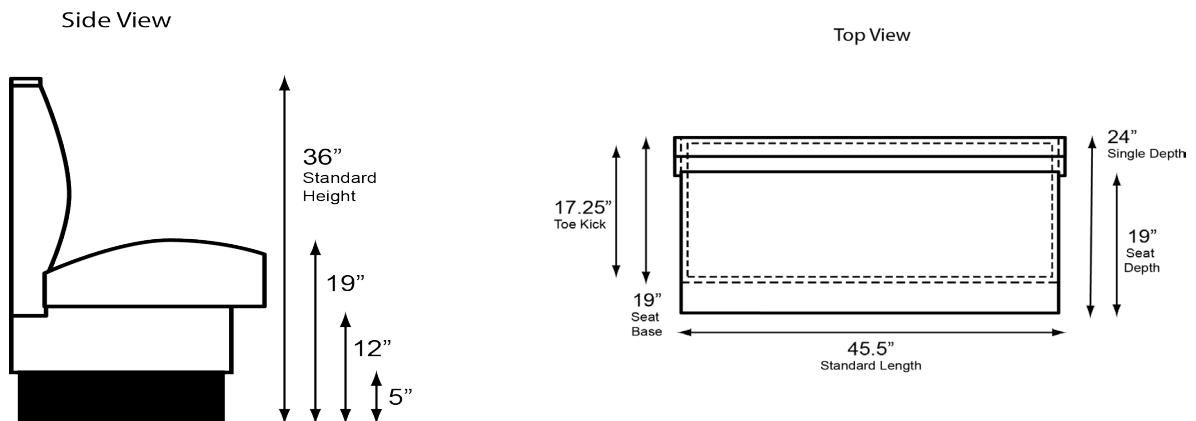



FES BRANDS

We've specialized in fulfilling foodservice product requirements
for over 30 years



FES BRANDS

FES Brands North America

2024 Catalog

Address:
1750 Stone Ridge Dr. Suite B
Stone Mountain, GA 30083

FESbrands.us
Email: Sales@fesbrands.us
TEL: 470-709-4628